

louis poulsen

A minimalist photograph of two Louis Poulsen lamps. One lamp is on a higher white rectangular block on the left, and the other is on a lower white rectangular block on the right. The lamps have black cylindrical shades and white circular shades. The background is a plain, light-colored wall.

PRICE LIST

RECOMMENDED RETAIL PRICES 2023

CONTACT

Louis Poulsen USA, Inc.
3260 Meridian Parkway
Weston, FL 33331

Phone: (954) 349-2525
Fax: (954) 349-2550

© Copyright 2020 by Louis Poulsen USA Inc.
All Rights Reserved.

The unauthorized reproduction and use of any design contained herein, including the duplication by photocopying or otherwise, of any design or part thereof, or of the specifications contained herein, for any purpose other than the specification of Louis Poulsen USA products, is a violation prohibited by law of Louis Poulsen USA's intellectual property rights, and will be subject to penalty.

Specifications subject to change without notice.

Prices shown in U.S. dollars supersede all previously published prices.

DESIGN TO SHAPE LIGHT

TABLE OF CONTENTS

Please note that prices displayed have been rounded up to nearest number and may not match invoiced totals absolutely



7
AJ Eklipta Surface



8
Ripis



9
Above



10
AJ Royal



11
Cirque



12
Collage 450/600



13
Dependant



14
Doo-Wop



15
Enigma 425



16
Enigma 545



17
Enigma 825



18
Keglen



19
LC Shutters



20
LP Centrum



21
Moser



22
OE Quasi Light



23
Patera



24
Patera Oval



25
PH 2/1 Pendant



26
PH 2-1 Stern Fitting



27
PH 3/3 Pendant



28
PH 3½-3 Glass Pendant



29
PH 3½-3 Pendant



30
PH 4½-4 Glass Pendant



31
PH 5



33
PH 5 Mini



34
PH 5/5 Pendant



35
PH 5-4½ & PH 6½-6



36
PH Artichoke



38
PH Artichoke Glass



39
PH Louvre



40
PH Septima



41
PH Snowball



42
Toldbod 6.1/8.7 Glass Pendant



43
Toldbod Pendant



44
VL Ring Crown 1



45
VL Ring Crown 3-5-7



46
VL45 Radiohus Pendant



47
Wohler



48
AJ Mini Table



49
AJ Oxford Table Lamp



50
AJ Table



51
Keglen Table



52
NJP Mini



53
NJP Table



54
Pantella MINI



55
Pantella Portable



56
Pantella Table



57
Pantella Table 320



58
PH 2/1 Table



59
PH 3/2 Glass Table



60
PH 3½-2½ Glass Table



61
PH 3½-2½ Table



62
PH 4/3 Table



63
PH 4½-3½ Glass Table



64
VL38 Table



65
Yuh Table



66
AJ Ekipta Wall



67
AJ Wall



68
Keglen Wall



69
NJP Wall



70
NJP Wall Box



71
PH 2-1 Wall



72
PH 3-2 Wall



73
PH Hat



74
Ripls



75
VL Ring Crown Wall



76
VL Studio Wall



77
VL38 Wall



78
Yuh Wall



79
AJ Floor



80
Keglen Floor



81
Moonsetter



82
NJP Floor



83
Pantella Floor



84
PH 3½-2½ Floor



85
PH 4½-3½ Glass Floor



86
PH 80



87
VL Studio Table/Floor



88
VL38 Floor



89
Yuh Floor



90
AJ 50 Wall



91
AJ Eklipta Outdoor



92
Flindt Wall



93
Nyhavn Wall



94
PH 3-2½ Wall



95
PH Wall



96
Skot Wall



97
Toldbod 6.1 Wall



98
AJ Garden Bollard



100
Bysted Garden Bollard



102
Flindt Garden Bollard



104
PH 3-2½ Bollard



105
Toldbod 6.1 Bollard

AJ EKLIPTA SURFACE

Surface Mounted

Design: Arne Jacobsen

Concept: The fixture emits soft comfortable light. The glass is designed to provide a uniformly lit surface. The three-layer hand blown opal glass shade has a transparent edge, providing a decorative halo of light around the fixture.

Finish: White, powder coated. White opal glass.

Material: Ceiling/Wall box: Spun aluminum. Diffuser: Hand blown white opal glass.

Mounting: Surface: Mounted directly to finished surface over a recessed 4" octagonal junction box (13.7"/17.7") or 3" octagonal junction box (8.7").

Weight: Max: 11 lbs.

Compliance: cULus, Wet location.

Info notes: Electrical:

LED System Wattage: 10W or 24W

LED Wattage: 9W or 22W

Delivered lumens: 371 - 1,937

Efficacy: 37.1 lm/W - 80.7 lm/W

Certifications: cULus, Wet Location (Incandescent variants), Damp location (LED variants)

Protection class IP20

Controllability: 0-10V Dimming, Phase Dimming

Color Rendering: Ra≥90

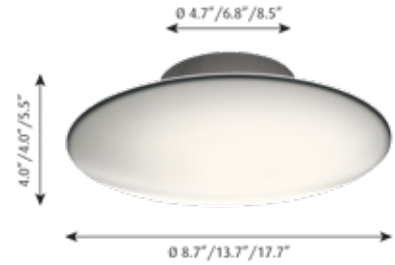

Product Code	Dimensions	Light source	Voltage	Finish	Mounting	Lighting control	Item number	Price
AJE	13.7 IN	10W LED/3000K	120-277V/60HZ	White	WALL AND SURFACE	DIM 0-10V	10000121108	1.378
AJE	13.7 IN	1x60W A-19/IF medium	120V	White	WALL AND SURFACE		5842905400	778
AJE	17.7 IN	1x100W A-19/IF medium	120V	White	WALL AND SURFACE		5842905426	1.038
AJE	17.7 IN	24W LED/3000K	120-277V/60HZ	White	WALL AND SURFACE	DIM 0-10V	10000121113	1.780
AJE	8.7 IN	10W LED/3000K	120V	White	WALL AND SURFACE		5743911192	756
AJE	8.7 IN	1x40W 30W G9	120V	White	WALL AND SURFACE		5743908011	664
Sparepart								
AJ EKLIPTA 220 GLASS							5743590005	386

RIPLS

Surface Mounted

Design: Jakob Wagner

Concept: The fixture emits diffused light. The front consists of a concave clear front with ripple like rings in water. The ripples refract light in the front creating a subtle change of appearance depending on viewing angle. The concave form outlines the refracting light creating a higher intensity light towards the center fading off toward the edges. A diffuser offset sits deep in the fixture creating a sense of depth in the front. A slim housing creates the appearance of a floating disk while perforations in the opaque housing allows indirect light to create a halo around the fixture.

Finish: White opal diffuser and clear reflective front. Satin matte white.

Material: Rear housing: Injection molded polycarbonate. Diffuser: Opalescent PMMA. Clear front: Clear UV resistant polycarbonate.

Mounting: Surface: mounted directly to finished surface over a recessed 4" octagonal junction box.

Weight: Max: 8 lbs.

Compliance: cULus, Damp location.

Info notes: Electrical:
 System Wattage: 13W or 25W
 LED Wattage: 12W or 23W
 Delivered lumens: 1,060 - 2,357
 Efficacy: 81.5 lm/W - 94.3 lm/W

Certifications:
 cULus, Damp Location
 Protection class IP20
 Controllability: 0-10V Dimming
 Color Rendering: Ra≥90



Product Code	Dimensions	Light source	Voltage	Finish	Lighting control	Item number	Price
RIPLS-CW	12.2 IN	13W LED/3000K	120-277V/60HZ	Opal	DIM 0-10V	10000140832	682
RIPLS-CW	12.2 IN	13W LED/3500K	120-277V/60HZ	Opal	DIM 0-10V	10000140833	682
RIPLS-CW	19.7 IN	25W LED/3000K	120-277V/60HZ	Opal	DIM 0-10V	10000140834	998
RIPLS-CW	19.7 IN	25W LED/3500K	120-277V/60HZ	Opal	DIM 0-10V	10000140835	998

ABOVE

Pendants

Design: Mads Odgård

Concept: The fixture emits soft comfortable downlight. The conical shape and the matte, white-painted inside help assure even distribution of the light. The opening at the top of the fixture provides decorative illumination of the arch above, and ensures that the fixture retains the full expression of its visual shape both when illuminated and when switched off.

Finish: White, matte or black, matte, wet painted.

Material: Shade: Spun aluminum.

Mounting: Canopy: Black. Cord type: 3-conductor, 18 AWG cloth-covered power cord. Cord length: 12 feet.

Weight: Max: 15 lbs.

Compliance: cULus, Dry location.

Info notes: Electrical:

System Wattage: 10W to 44W

LED Wattage: 9 W or 42 W

Delivered lumens: 351 - 3,160

Efficacy: 35.1 lm/W - 71.8 lm/W

Dim-to-warm LED 3000K (100%) to 1800K (10%)

Certifications:

cULus, Dry Location

Protection class IP20

Controllability: Phase dimming or 0-10V dimming.

Color Rendering: Ra≥90 for LED variants.

Performance dependent upon screw-base lamp used in socketed variants.



Product Code	Dimensions	Light source	Voltage	Finish	Cable type	Lighting control	Item number	Price
ABOVE-P	15.7 IN	1x22W A-21/medium	120V	Black	BLACK TEXTILE		5741925384	1.030
ABOVE-P	15.7 IN	1x22W A-21/medium	120V	White	BLACK TEXTILE		5741925371	1.030
ABOVE-P	15.7 IN	44W LED/3000-1800K D2W	120-277V/60HZ	Black	BLACK TEXTILE	DIM 0-10V	10000149859	1.670
ABOVE-P	15.7 IN	44W LED/3000-1800K D2W	120V	Black	BLACK TEXTILE	PHASE DIMMING (MAINS DIMM)	10000149863	1.670
ABOVE-P	15.7 IN	44W LED/3000-1800K D2W	120-277V/60HZ	White	BLACK TEXTILE	DIM 0-10V	10000149860	1.670
ABOVE-P	15.7 IN	44W LED/3000-1800K D2W	120V	White	BLACK TEXTILE	PHASE DIMMING (MAINS DIMM)	10000149864	1.670
ABOVE-P	15.7 IN	44W LED/3000K	120-277V/60HZ	Black	BLACK TEXTILE	DIM 0-10V	10000149691	1.670
ABOVE-P	15.7 IN	44W LED/3000K	120V	Black	BLACK TEXTILE	PHASE DIMMING (MAINS DIMM)	10000149855	1.670
ABOVE-P	15.7 IN	44W LED/3000K	120-277V/60HZ	White	BLACK TEXTILE	DIM 0-10V	10000149852	1.670
ABOVE-P	15.7 IN	44W LED/3000K	120V	White	BLACK TEXTILE	PHASE DIMMING (MAINS DIMM)	10000149856	1.670
ABOVE-P	6.9 IN	1x10W A-15/medium	120V	Black	BLACK TEXTILE		5741919743	484
ABOVE-P	6.9 IN	1x10W A-15/medium	120V	White	BLACK TEXTILE		5741919730	484
ABOVE-P	9.8 IN	1x15W A-19/medium	120V	Black	BLACK TEXTILE		5741919769	652
ABOVE-P	9.8 IN	1x15W A-19/medium	120V	White	BLACK TEXTILE		5741919756	652

*Available while stocks last

AJ ROYAL

Pendants

Design: Arne Jacobsen

Concept: The pendant comes in three sizes and is characterized by the ridges on top that allow a gentle light to exude upwards. In the new, energy-saving LED version, all three sizes come with a diffuser, which offers a smoother, 100% glare-free lighting.

Finish: White or black, wet painted.

Material: Shades: Spun aluminum. Rings: Steel. Diffuser: Frosted acrylic.

Mounting: Cord type: 18 AWG braided fabric covered power cord. Cord length: 12'. Black canopy and cord for black pendant, white canopy and cord for white pendant.



Compliance: cULus, Damp location.

Info notes: Electrical:

System Wattage: 8W or 30W

LED Wattage: 7 W or 28 W

Delivered lumens: 508 - 2,309

Efficacy: 63.5 lm/W - 77.0 lm/W

Certifications:

cULus, Damp Location

Protection class IP20

Controllability: 0-10V Dimming

Color Rendering: Ra≥90

Dimensions	Light source	Voltage	Finish	Cable type	Lighting control	Item number	Price
14.6 IN	16W LED/2700K	120-277V/60HZ	Black	BLACK TEXTILE AND WIRE	PHASE+DIM 0-10V	10000151337	1.396
14.6 IN	16W LED/2700K	120-277V/60HZ	White	WHITE TEXTILE AND WIRE	PHASE+DIM 0-10V	10000151340	1.396
14.6 IN	16W LED/3000K	120-277V/60HZ	Black	BLACK TEXTILE AND WIRE	PHASE+DIM 0-10V	10000151333	1.396
14.6 IN	16W LED/3000K	120-277V/60HZ	White	WHITE TEXTILE AND WIRE	PHASE+DIM 0-10V	10000151334	1.396
19.7 IN	30W LED/2700K	120-277V/60HZ	Black	WHITE TEXTILE AND WIRE	PHASE+DIM 0-10V	10000151347	1.906
19.7 IN	30W LED/2700K	120-277V/60HZ	White	BLACK TEXTILE AND WIRE	PHASE+DIM 0-10V	10000151345	1.906
19.7 IN	30W LED/3000K	120-277V/60HZ	Black	BLACK TEXTILE AND WIRE	PHASE+DIM 0-10V	10000151341	1.906
19.7 IN	30W LED/3000K	120-277V/60HZ	White	WHITE TEXTILE AND WIRE	PHASE+DIM 0-10V	10000151342	1.906
9.8 IN	9W LED/2700K	120-277V/60HZ	Black	BLACK TEXTILE AND WIRE	PHASE+DIM 0-10V	10000151329 *	966
9.8 IN	9W LED/2700K	120-277V/60HZ	White	WHITE TEXTILE AND WIRE	PHASE+DIM 0-10V	10000151330 *	966
9.8 IN	9W LED/3000K	120-277V/60HZ	Black	BLACK TEXTILE AND WIRE	PHASE+DIM 0-10V	10000151801 *	966
9.8 IN	9W LED/3000K	120-277V/60HZ	White	WHITE TEXTILE AND WIRE	PHASE+DIM 0-10V	10000151803 *	966

*Available while stocks last

CIRQUE

Pendants

Design: Clara von Zweigbergk

Concept: The fixture provides a downward glare-free soft light by means of the white lacquered inner reflector.

Finish: Grey top, Copper top, Red top, Yellow top, wet painted.

Material: Shield: Drawn aluminum.

Mounting: Canopy: White. Cord type: 3-conductor, 18 AWG white PVC power cord. Cord length: 12'.

Weight: Max: 4 lbs.

Compliance: cULus, Damp location.

Info notes: Electrical:

System Wattage: 10W or 22W

LED Wattage: 9 W or 20 W

Delivered lumens: 356 - 832

Efficacy: 35.6 lm/W - 37.8 lm/W

Certifications:

cULus, Dry Location

Protection class IP20

Controllability: Phase dimming

Actual performance dependent upon screw-base lamp used.



Product Code	Dimensions	Light source	Voltage	Finish	Cable type	Item number	Price
CIRQUE-P	15 IN	1x22W A-21/medium	120V	Copper Top	WHITE TEXTILE	5741919772	1.042
CIRQUE-P	15 IN	1x22W A-21/medium	120V	Grey Top	WHITE TEXTILE	5741919895	1.042
CIRQUE-P	15 IN	1x22W A-21/medium	120V	Red Top	WHITE TEXTILE	5741919785	1.042
CIRQUE-P	15 IN	1x22W A-21/medium	120V	Yellow Top	WHITE TEXTILE	5741919798	1.042
CIRQUE-P	5.9 IN	1x10W A-15/medium	120V	Copper Top	WHITE TEXTILE	5741919837	484
CIRQUE-P	5.9 IN	1x10W A-15/medium	120V	Grey Top	WHITE TEXTILE	5741919918	484
CIRQUE-P	5.9 IN	1x10W A-15/medium	120V	Red Top	WHITE TEXTILE	5741919840	484
CIRQUE-P	5.9 IN	1x10W A-15/medium	120V	Yellow Top	WHITE TEXTILE	5741919853	484
CIRQUE-P	8.7 IN	1x15W A-19/medium	120V	Copper Top	WHITE TEXTILE	5741919808	706
CIRQUE-P	8.7 IN	1x15W A-19/medium	120V	Grey Top	WHITE TEXTILE	5741919905	706
CIRQUE-P	8.7 IN	1x15W A-19/medium	120V	Red Top	WHITE TEXTILE	5741919811	706
CIRQUE-P	8.7 IN	1x15W A-19/medium	120V	Yellow Top	WHITE TEXTILE	5741919824	706
Sparepart							
CIRQUE 150 SUSP 10W E26 V2 US						5741919882	188
CIRQUE 220 SUSP 15W E26 V2 US						5741919879	218
CIRQUE 380 SUSP 22W E26 V2 US						5741919866	242
CIRQUE 150 SHADE GREY TOP						5741099760	354
CIRQUE 220 SHADE GREY TOP						5741099757	532
CIRQUE 380 SHADE GREY TOP						5741099744	834

COLLAGE 450/600

Pendants

Design: Louise Campbell

Concept: The fixture emits diffused light directed primarily downwards. The patterns on the three laser cut acrylic shades have been carefully staggered with the aim of eliminating unpleasant glare from the light source. The patterns differ between the shades, resulting in different perceptions of light and shadow depending on the viewing angle.

Finish: White matte.

Material: Suspension: Naturally anodized aluminum. Shades: Laser cut acrylic.

Mounting: Canopy: White. Cord type: 3-conductor, 18 AWG white PVC power cord. Cord length: 12'.

Weight: Max: 8 lbs.

Compliance: cULus, Dry location.

Info notes: Electrical:
 System Wattage: 22W
 LED Wattage: 20 W
 Delivered lumens: 1,625
 Efficacy: 73.9 lm/W

Certifications:
 cULus, Dry Location
 Protection class IP20
 Controllability: Phase dimming
 Actual performance dependent upon screw-base lamp used.



Product Code	Dimensions	Light source	Voltage	Finish	Cable type	Item number	Price
COL-450-P	17.7 IN	1x22W A-21/medium	120V	White Matte	WHITE TEXTILE	5741928679	1.546
COL-450-P	23.6 IN	1x22W A-21/medium	120V	White Matte	WHITE TEXTILE	5741928682	2.428
Accessories							
COLLAGE 450 ANTI-GLARE BOT.SHAD. MAT						5741095191	144
COLLAGE 450 ANTI-GLARE TOPSHADE MAT						5741095201	96

DEPENDANT

Pendants

Design: Kilo Design

Concept: The suspension system allows the clustering of multiple pendants to create larger installations. It comes in linear and circular versions, both available in two dimensions. The linear system holds either three or five pendants, while the circular system holds four or six pendants.

Each pendant is suspended on the cord that has been provided with it. The system allows each pendant to be positioned at the preferred height. The system is easy to install and comes in three finishes to match the suspended pendants.

Finish: Metalized brass, or powder-coated black or white.

Material: Canopy, tubes and fittings: Aluminum. Grommets, fitting inserts and set screws: PC, white or black. Clear PVC coated wires: Steel or black. Set screws in canopy: Steel or black.

White suspension has white canopy, white fitting inserts plus steel wires.
 Black suspension has black canopy, black fitting inserts and black wires.
 Brass metallised suspensions has either white or black canopy plus the corresponding set of fitting inserts and wires.

Mounting: Canopy is mounted directly onto ceiling over a 4-inch octagonal outlet box. Terminal connections inside canopy for individual pendant cords. Weight is held by stainless steel aircraft cable(s) between canopy and horizontal rods. Set screws secure pendant cords at horizontal rods for vertical adjustment. Length of suspension cable: 13 ft. Maximum system weight of 50 lbs. including suspension and pendants.

Compliance: cULus, Dry location.

Info notes: Can only be used for socket-based pendants up to 11 lbs each that do not include aircraft-style suspension wires. Not applicable for pendants with dedicated LEDs and canopy-mounted drivers.

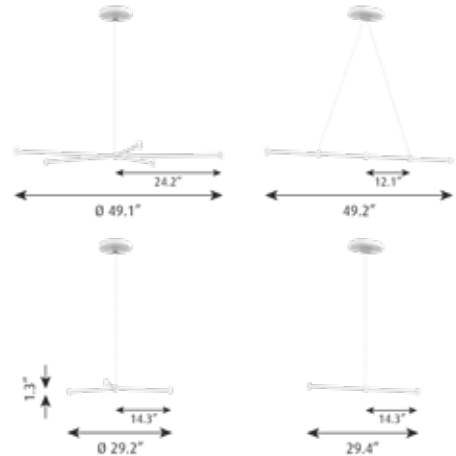

Dimensions	Finish	Item number	Price
3 LINEAR	Black	10000157438	574
3 LINEAR	Brass Metalized/Black	10000157436	726
3 LINEAR	Brass Metalized/White	10000158894	726
3 LINEAR	White	10000157437	574
4 CIRCULAR	Black	10000157441	726
4 CIRCULAR	Brass Metalized/Black	10000157439	952
4 CIRCULAR	Brass Metalized/White	10000158892	952
4 CIRCULAR	White	10000157440	726
5 LINEAR	Black	10000157444	774
5 LINEAR	Brass Metalized/Black	10000157442	1.084
5 LINEAR	Brass Metalized/White	10000158895	1.084
5 LINEAR	White	10000157443	774
6 CIRCULAR	Black	10000157447	952
6 CIRCULAR	Brass Metalized/Black	10000157445	1.394
6 CIRCULAR	Brass Metalized/White	10000158893	1.394
6 CIRCULAR	White	10000157446	952
Sparepart			
DEPENDANT 3/5 CANOPY BLACK US		5741936234	286
DEPENDANT 3/5 CANOPY WHITE US		5741936247	286
DEPENDANT 4/6 CANOPY BLACK US		5741936292	286
DEPENDANT 4/6 CANOPY WHITE US		5741936302	286

DOO-WOP

Pendants

Design: Louis Poulsen A/S in cooperation with the Navy Buildings Department

Concept: The fixture primarily provides a downward directed soft light by means of the white lacquered inner conical reflector. The outer reflector, the main shade, contributes to directing the light upwards and downwards, while at the same time spreading the soft diffused light. The inside of the main shade is illuminated through an opening in the inner conical reflector.

Finish: White or Dark Grey, powder coated or polished Brass, Copper or Stainless Steel.

Material: Shade: Spun aluminum or spun brass, copper, or stainless steel.
Suspension: Spun aluminum. **Struts:** Stainless steel.

Mounting: Canopy: White. Cord type: 3-conductor, 18 AWG white PVC power cord. Cord length: 12'.

Weight: Max: 4 lbs.

Compliance: cULus, Damp location.

Info notes: Please note that the brass, copper and stainless steel surfaces are untreated. This means that the surface will change over time and develop a patina. This process may have already begun when the product is delivered. Electrical:

System Wattage: 15W

LED Wattage: 15W

Delivered lumens: 551

Efficacy: 36 lm/W

Certifications:

cULus, Damp Location

Protection class IP20

Controllability: Phase dimming

Actual performance dependent upon screw-base lamp used.

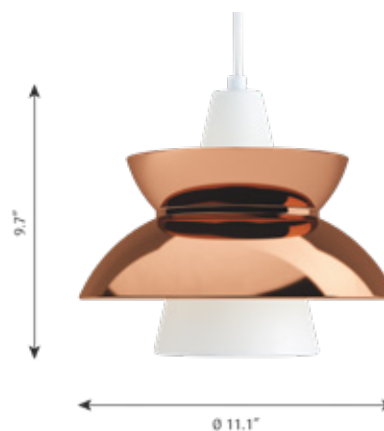

Product Code	Light source	Voltage	Finish	Cable type	Item number	Price
DOO-WOP	1x15W A-19/medium	120V	Brass	WHITE TEXTILE	5741919921	1.220
DOO-WOP	1x15W A-19/medium	120V	Copper	WHITE TEXTILE	5741919950	1.220
DOO-WOP	1x15W A-19/medium	120V	Dark Grey	WHITE TEXTILE	5741919934	748
DOO-WOP	1x15W A-19/medium	120V	Stainless Steel Polished	WHITE TEXTILE	5741919963 *	1.220
DOO-WOP	1x15W A-19/medium	120V	White	WHITE TEXTILE	5741919947	748

*Available while stocks last

ENIGMA 425

Pendants

Design: Shoichi Uchiyama

Concept: The fixture emits glare-free, soft, comfortable downward light. The shade design ensures even illumination of the surface. The matte upper surface diffuses the light, while the shiny lower surface ensures optimal reflection.

Finish: Brushed aluminum, clear coated or black wet painted. Shades: White or black acrylic.

Material: Cone and pendant tube: Lacquered or wet painted brushed aluminum. Wire: Stainless steel. Shades: Acrylic.

Mounting: Canopy: White. Cord type: 3-conductor, 18 AWG white PVC power cord. Cord length: 12'.

Compliance: cULus, Dry location.

Info notes: Electrical:

System Wattage: 8W

LED Wattage: 7 W

Delivered lumens: 341 - 487

Efficacy: 42.6 lm/W - 60.9 lm/W

Certifications:

cULus, Dry Location

Protection class IP20

Controllability: Phase dimming

Actual performance dependent upon screw-base lamp used.

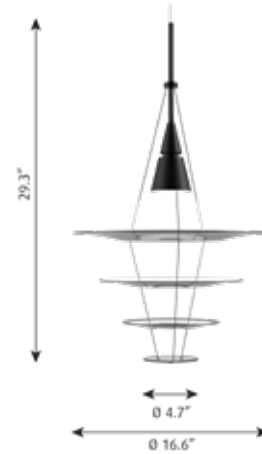

Light source	Voltage	Finish	Cable type	Item number	Price
1x8W 1/50W/PAR16 GU10	120V	Black	BLK	10000146255	1.168
1x8W 1/50W/PAR16 GU10	120V	BR ALU	WHT	10000146254	1.168
Sparepart					
ENIGMA PENDANT, SHADE 120 W/BUSH. WHITE				5741086786	144
ENIGMA PENDANT SHADE 120 W/BUSH. BLK				5741088878	144
ENIGMA PENDANT, SHADE 210 WHITE				5741086799	156
ENIGMA PENDANT SHADE 210 BLK				5741088881	156
ENIGMA PENDANT, SHADE 310 WHITE				5741086809	172
ENIGMA PENDANT SHADE 310 BLK				5741088894	172
ENIGMA PENDANT, SHADE 422 WHITE				5741086812	230
ENIGMA PENDANT SHADE 422 BLK				5741088904	230

ENIGMA 545

Pendants

Design: Shoichi Uchiyama

Concept: The fixture emits glare-free, soft, comfortable downward light. The shade design ensures even illumination of the surface. The matte upper surface diffuses the light, while the glossy lower surface ensures optimal reflection.

Finish: Brushed aluminum, clear coated or black wet painted. Shades: White or black acrylic.

Material: Cone and pendant tube: Lacquered or wet painted brushed aluminum. Wire: Stainless steel. Shades: Acrylic.

Mounting: Canopy: White. Cord type: 3-conductor, 18 AWG white PVC power cord. Cord length: 12'.

Compliance: cULus, Dry location.

Info notes: Electrical:
 System Wattage: 8W
 LED Wattage: 7 W
 Delivered lumens: 341 - 487
 Efficacy: 42.6 lm/W - 60.9 lm/W

Certifications:
 cULus, Dry Location
 Protection class IP20
 Controllability: Phase dimming
 Actual performance dependent upon screw-base lamp used.

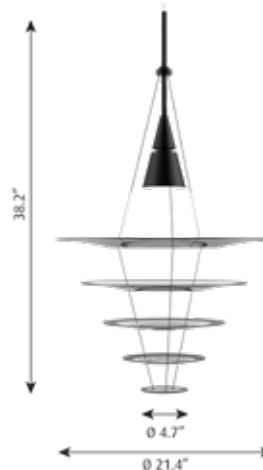

Light source	Voltage	Finish	Cable type	Item number	Price
1x8W 1/50W/PAR16 GU10	120V	Black	BLK	10000146257	1.924
1x8W 1/50W/PAR16 GU10	120V	BR ALU	WHT	10000146256	1.924
Sparepart					
ENIGMA PENDANT, SHADE 120 W/BUSH. WHITE				5741086786	144
ENIGMA PENDANT SHADE 120 W/BUSH. BLK				5741088878	144
ENIGMA PENDANT, SHADE 210 WHITE				5741086799	156
ENIGMA PENDANT SHADE 210 BLK				5741088881	156
ENIGMA PENDANT, SHADE 310 WHITE				5741086809	172
ENIGMA PENDANT SHADE 310 BLK				5741088894	172
ENIGMA PENDANT, SHADE 422 WHITE				5741086812	230
ENIGMA PENDANT SHADE 422 BLK				5741088904	230
ENIGMA PENDANT, SHADE 545 WHITE				5741087099	402
ENIGMA PENDANT SHADE 545 BLK				5741088917	402

ENIGMA 825

Pendants

Design: Shoichi Uchiyama

Concept: The fixture emits glare-free, soft, comfortable, downward light. The shade design ensures even illumination of the surface. The matte upper surface diffuses the light, while the glossy lower surface ensures optimal reflection.

Finish: Aluminum colored or black, wet painted brushed aluminum. Shades: White or black acrylic.

Material: Cone and pendant tube: Wet painted brushed aluminum. Wire: Stainless steel. Shades: Acrylic.

Mounting: Suspension type: 1x stainless steel aircraft cable. Canopy: White or black. Cord type: 2-conductor, 18 AWG white or black PVC power cord. Cord length: 12'.

Weight: Max: 16 lbs.

Compliance: cULus, Damp location.

Info notes: Electrical:
 System Wattage: 62W
 LED Wattage: 57 W
 Delivered lumens: 3,401 - 5,883
 Efficacy: 54.9 lm/W - 94.9 lm/W

Certifications:
 cULus, Damp Location
 Protection class IP20
 Controllability: 0-10V Dimming
 Color Rendering: Ra≥90

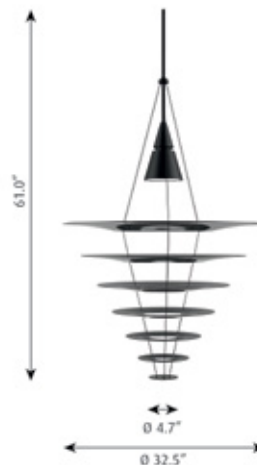

Product Code	Light source	Voltage	Finish	Cable type	Lighting control	Item number	Price
ENIG825	62W LED/3000K	120-277V/60HZ	Black	BLK	DIM 0-10V	5741918757	4.876
ENIG825	62W LED/3000K	120-277V/60HZ	BR ALU	TRANSPARENT CABLE	DIM 0-10V	5741918760	4.876
Sparepart							
ENIGMA PENDANT, SHADE 120 W/BUSH. WHITE						5741086786	144
ENIGMA PENDANT SHADE 120 W/BUSH. BLK						5741088878	144
ENIGMA PENDANT, SHADE 210 WHITE						5741086799	156
ENIGMA PENDANT SHADE 210 BLK						5741088881	156
ENIGMA PENDANT, SHADE 310 WHITE						5741086809	172
ENIGMA PENDANT SHADE 310 BLK						5741088894	172
ENIGMA PENDANT, SHADE 422 WHITE						5741086812	230
ENIGMA PENDANT SHADE 422 BLK						5741088904	230
ENIGMA 825 SUSP 3,7M CABLE W/LED BLK US						5741918870	3.522
ENIGMA PENDANT, SHADE 545 WHITE						5741087099	402
ENIGMA PENDANT SHADE 545 BLK						5741088917	402

KEGLEN

Pendants

Design: Big Ideas

Concept: The pendants distinctive conical shades each have a built-in curved opal insert. This ensures a both attractive and glare-free downward light. Each version of the shade provides its own diffusion of light while the white inner side ensures that its light is reflected flawlessly. A gentle light is also emitted upwards through a uniform, discreet opening in the top of the shades which adds to the perfect ambiance.

Finish: Black or white, matte, wet painted.

Material: Shade: Spun aluminum.
Diffusor: Injection molded PC.

Mounting: Suspension type: 1x black stainless steel aircraft cable. Cord type: 18 AWG braided fabric covered power cord. Cord length: 12'. Black canopy and cord for black pendant, white canopy and cord for white pendant.

Weight: Max. 15 lbs.

Compliance: cULus, Damp location.

Info notes: Electrical:
System Wattage: 6W, 8W, 21W or 31W
LED Wattage: 5W, 7W, 19W, or 29W
Delivered lumens: 276 - 2,254 lm
Efficacy: 50 lm/W - 73 lm/W
Certifications: cULus, Damp
Controllability: 0-10V Dimming
Color Rendering: Ra≥90



Dimensions	Light source	Voltage	Finish	Cable type	Lighting control	Item number	Price
15.7 IN	21W LED/2700K	120-277V/60HZ	Black	BLACK TEXTILE AND WIRE	PHASE+DIM 0-10V	10000151388	1.176
15.7 IN	21W LED/2700K	120-277V/60HZ	White	WHITE TEXTILE AND WIRE	PHASE+DIM 0-10V	10000151390	1.176
15.7 IN	21W LED/3000K	120-277V/60HZ	Black	BLACK TEXTILE AND WIRE	PHASE+DIM 0-10V	10000151384	1.176
15.7 IN	21W LED/3000K	120-277V/60HZ	White	WHITE TEXTILE AND WIRE	PHASE+DIM 0-10V	10000151386	1.176
25.6 IN	31W LED/2700K	120-277V/60HZ	Black	BLACK TEXTILE AND WIRE	PHASE+DIM 0-10V	10000151396	1.786
25.6 IN	31W LED/2700K	120-277V/60HZ	White	WHITE TEXTILE AND WIRE	PHASE+DIM 0-10V	10000151398	1.786
25.6 IN	31W LED/3000K	120-277V/60HZ	Black	BLACK TEXTILE AND WIRE	PHASE+DIM 0-10V	10000151392	1.786
25.6 IN	31W LED/3000K	120-277V/60HZ	White	WHITE TEXTILE AND WIRE	PHASE+DIM 0-10V	10000151394	1.786
6.9 IN	6W LED/2700K	120-277V/60HZ	Black	BLACK TEXTILE AND WIRE	DIM 0-10V	10000151372	678
6.9 IN	6W LED/2700K	120V	Black	BLACK TEXTILE AND WIRE	PHASE DIMMING (MAINS DIMM)	10000155282	678
6.9 IN	6W LED/2700K	120-277V/60HZ	White	WHITE TEXTILE AND WIRE	DIM 0-10V	10000151374	678
6.9 IN	6W LED/2700K	120V	White	WHITE TEXTILE AND WIRE	PHASE DIMMING (MAINS DIMM)	10000155306	678
6.9 IN	6W LED/3000K	120-277V/60HZ	Black	BLACK TEXTILE AND WIRE	DIM 0-10V	10000151368	678
6.9 IN	6W LED/3000K	120V	Black	BLACK TEXTILE AND WIRE	PHASE DIMMING (MAINS DIMM)	10000155307	678
6.9 IN	6W LED/3000K	120-277V/60HZ	White	WHITE TEXTILE AND WIRE	DIM 0-10V	10000151370	678
6.9 IN	6W LED/3000K	120V	White	WHITE TEXTILE AND WIRE	PHASE DIMMING (MAINS DIMM)	10000155308	678
9.8 IN	8W LED/2700K	120-277V/60HZ	Black	BLACK TEXTILE AND WIRE	PHASE+DIM 0-10V	10000151380	922
9.8 IN	8W LED/2700K	120-277V/60HZ	White	WHITE TEXTILE AND WIRE	PHASE+DIM 0-10V	10000151382	922
9.8 IN	8W LED/3000K	120-277V/60HZ	Black	BLACK TEXTILE AND WIRE	PHASE+DIM 0-10V	10000151376	922
9.8 IN	8W LED/3000K	120-277V/60HZ	White	WHITE TEXTILE AND WIRE	PHASE+DIM 0-10V	10000151378	922

Sparepart

CANOPY SHADE BLACK KEGLEN	10000151814	Contact LP
CANOPY SHADE WHITE KEGLEN	10000151815	Contact LP

LC SHUTTERS

Pendants

Design: Louise Campbell

Concept: The fixture emits a primarily downward illumination. The perforated pattern on the shade provides a soft illumination around the fixture. Meanwhile, the perforation helps lighten up the surface of the shade in a decorative way, when it is turned on, thereby maintaining the contour of the fixture, whether it is on or off. The light source is surrounded by an opal diffuser, which ensures that the fixture is 100% glare-free. And finally, the shape of the diffuser allows a beautiful view into the fixture.

Finish: White, powder coated.

Material: Shade: Spun aluminum, punched and embossed. Suspension: Die cast aluminum. Diffuser ball: handblown matte white opal glass.

Mounting: Cord type: 2-conductor, 18 AWG white PVC power cord. Canopy: White. Cord length: 12'.

Weight: Max: 6 Lbs.

Compliance: cULus, Damp location.

Info notes: Electrical:
 System Wattage: 15W
 Delivered lumens: 1,521
 Efficacy: 101 lm/W

Certifications:
 cULus, Damp Location
 Protection class IP20
 Controllability: Phase dimming
 Actual performance dependent upon screw-base lamp used.



Product Code	Light source	Voltage	Finish	Cable type	Item number	Price
LC-SHUT-P	1x15W E26	120V	White	WHT	5741913396	1.004

LP CENTRUM

Pendants

Design: Kurt Nørregaard, Poul Henningsen

Concept: The fixture provides 100% glare-free light. Its geometric design is based according to the mathematical lituus curve. All the illuminated surfaces are hit by the light at the same angle, casting the light into the room under the same conditions. This results in both horizontal and vertical light emission.

Finish: White, wet painted.

Material: Shades: Spun aluminum. Frame: Extruded, anodized aluminum.
Suspension: Spun aluminum.

Mounting: Suspension type: 1x PVC covered stainless steel aircraft cable. Canopy: White. Cord type: 3-conductor, 18 AWG white PVC power cord for MH or 5-conductor cord for LED light sources. Cord length: 12'.

Weight: Max: 38 lbs.

Compliance: cULus, Dry location.

Info notes: Electrical:
System Wattage: 36W
LED Wattage: 33 W
Delivered lumens: 2,050 - 2,142
Efficacy: 56.9 lm/W - 59.5 lm/W

Certifications:
cULus, Damp Location
Protection class IP20
Controllability: 0-10V Dimming
Color Rendering: Ra≥90

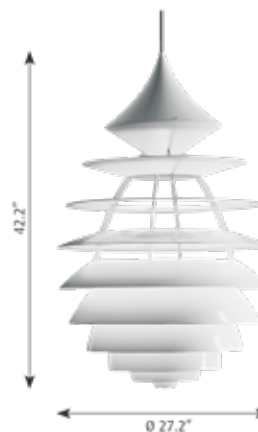

Product Code	Light source	Voltage	Finish	Cable type	Lighting control	Item number	Price
LPC	36W LED/2700K	120-277V/60HZ	White	WHT	DIM 0-10V	10000150713	13.988
LPC	36W LED/3000K	120-277V/60HZ	White	WHT	DIM 0-10V	10000150712	13.988

MOSER

Pendants

Design: Anu Moser

Concept: The fixture emits diffused light and the thickness of the glass results in a very comfortable light distribution.

Finish: Matte white opal.

Material: Suspension: Polished aluminum. Shade: hand blown matte white opal glass.

Mounting: Canopy: White. Cord type: 3-conductors, 18 AWG white PVC power cord. Cord length: 12'.

Weight: Max: 7 lbs.

Compliance: cULus, Damp location.

Info notes: Electrical:
 System Wattage: 15W
 LED Wattage: 14 W
 Delivered lumens: 664
 Efficacy: 44.3 lm/W

Certifications:
 cULus, Dry Location
 Protection class IP20
 Controllability: Phase dimming
 Actual performance dependent upon screw-base lamp used.



Product Code	Dimensions	Light source	Voltage	Finish	Item number	Price
MOS	7.3 IN	1x15W A-19/medium	120V	Matte White Opal Glass	5741913024	726
MOS	8.1 IN	1x15W A-19/medium	120V	Matte White Opal Glass	5741913037	820
MOS	9.8 IN	1x15W A-19/medium	120V	Matte White Opal Glass	5741913040	882

OE QUASI LIGHT

Pendants

Design: Olafur Eliasson

Concept: The pendant has 12 LEDs embedded in the inner vertices of the geometric frame that are connected to light guides along the inner edges, creating an even illumination towards the reflector in the center of the lamp. This layered white core reflects the light spherically back into the room, resulting in glare-free and uniform light.

Finish: Clear lacquered, pickled aluminum. Matte white reflector.

Material: Frame: Aluminum. Reflector: Injection molded polycarbonate

Mounting: Suspension type: 1x stainless steel aircraft cable. Canopy: White. Cord type: 2-conductor, 18 AWG white PVC power cord. Cord length: 12'.



Compliance: Compliance: cULus, Damp location.

Info notes: Electrical:

System Wattage: 118W

LED Wattage: 109 W

Delivered lumens: 2,950 - 3,085

Efficacy: 25.0 lm/W - 26.1 lm/W

Certifications:

cULus, Damp Location

Protection class IP20

Controllability: 0-10V Dimming

Color Rendering: Ra≥90

Dimensions	Light source	Voltage	Finish	Lighting control	Item number	Price
33.1 IN	118W LED/2700K	120-277V/60HZ	Dark Aluminum	DIM 0-10V	10000149807	22.112
33.1 IN	118W LED/3000K	120-277V/60HZ	Dark Aluminum	DIM 0-10V	10000149808	22.112

PATERA

Pendants

Design: Øivind Slaatto

Concept: This spherical pendant emits a glare-free glow of light, which is reflected by the small diamond-shaped cells that comprise the fixture. The lamp's structure ensures that the light is glare-free from above 45 degrees while also allowing the fixture to emit a downwardly directed light as well as an upward radiance, illuminating the ceiling to lend further ambiance to its surroundings. Each cell shapes the light by creating soft transitions between direct and reflected light to emphasize the pendant's remarkably radiant sphere.

Finish: White, matte-coated.

Material: Shade: Cut, matte, PVC foil.

Suspension: Matte-chromed aluminum and die-cast acrylic.

Mounting: Canopy: White. Cord type: 2-conductor, 18 AWG white PVC power cord. Cord length: 12'. LED variants include 1x stainless steel aircraft cable.

Weight: Max 15 lbs.

Compliance: cULus, Damp location.

Info notes: Electrical:

System Wattage: 42W, 65W or 97W (LED)

40W, 100W or 200W (INC)

LED Wattage: 40W, 62W, or 89 W

Delivered lumens: 2,307 - 4,291 (LED)

Efficacy: 44 lm/W - 60 lm/W (LED)

Certifications:

cULus, Dry Location

Protection class IP20

Controllability: 0-10V Dimming (LED variants); Phase dimming (incandescent variants)

Color Rendering: Ra≥90 for LED variants.

Performance dependent upon screw-base lamp used in socketed variants.



Product Code	Dimensions	Light source	Voltage	Finish	Cable type	Lighting control	Item number	Price
PATE-P	11.8 IN	A-19/IF medium	120V	White			5741934142	1.162
PATE-P	17.7 IN	1x100W A-19/IF medium	120V	White	WHITE TEXTILE		5741925151	1.608
PATE-P	17.7 IN	42W LED/2700K	120-277V/60HZ	White	WHITE TEXTILE	DIM 0-10V	5741935138	2.438
PATE-P	17.7 IN	42W LED/3000K	120-277V/60HZ	White	WHITE TEXTILE	DIM 0-10V	5741935141	2.438
PATE-P	23.6 IN	1x200W A-23W/IF medium	120V	White	WHITE TEXTILE		5741925216	2.480
PATE-P	23.6 IN	65W LED/2700K	120-277V/60HZ	White	WHITE TEXTILE	DIM 0-10V	5741925229	4.150
PATE-P	23.6 IN	65W LED/3000K	120-277V/60HZ	White	WHITE TEXTILE	DIM 0-10V	5741925232	4.150
PATE-P	35.4 IN	1x200W A-23W/IF medium	120V	White	WHITE TEXTILE		10000149361	5.520
PATE-P	35.4 IN	97W LED/2700K	120-277V/60HZ	White	WHITE TEXTILE	DIM 0-10V	10000149264	7.482
PATE-P	35.4 IN	97W LED/3000K	120-277V/60HZ	White	WHITE TEXTILE	DIM 0-10V	10000149362	7.482

PATERA OVAL

Pendants

Design: Øivind Slaatto

Concept: The pendant is a glowing ellipsoid made up of diamond-shaped cells. Each cell has been carefully designed to capture light and to conceal the light source when viewed from angles above 40 degrees. Below 40 degrees, the lamp provides direct, downward light. The round opening underneath provides direct light with a soft transition toward the reflected light. The pendant can be used with or without a diffuser plate, depending on whether or not the view of the light source creates an unwanted glare.

Finish: White, matte coated.

Material: Shade: matte PVC sheet. Frame: White, opal, matte-coated injection-molded polycarbonate with steel reinforcing rods. Stem: aluminum. LED: Aluminum heatsink. Bottom diffuser: Injection-molded opal white acrylic.

Mounting: Canopy: White. Cord type: 2-conductor, 18 AWG white cloth-covered power cord. Cord length: 12'. LED: Canopy contains driver.

Weight: Max. 3.4 kg

Compliance: cULus, Damp location.

Info notes: Electrical:

System Wattage: 41W (LED); 40W (INC)

LED

Wattage: 39W

Delivered lumens: 2,553 - 2,656 (LED)

Efficacy: 62 lm/W - 65 lm/W (LED)

Certifications:

cULus, Damp Location

Protection class IP20

Controllability: 0-10V Dimming (LED variants); Phase dimming (incandescent variant)

Color Rendering: Ra≥90 for LED variants.

Performance dependent upon screw-base lamp used in socketed variants.



Dimensions	Light source	Voltage	Finish	Cable type	Lighting control	Item number	Price
19.7 IN	1x22W E26	120V	White Matte	WHITE TEXTILE		5741936014	1.656
19.7 IN	41W LED/2700K	120-277V/60HZ	White Matte	WHITE TEXTILE	DIM 0-10V	5741936069	2.312
19.7 IN	41W LED/3000K	120-277V/60HZ	White Matte	WHITE TEXTILE	DIM 0-10V	5741936072	2.312

PH 2/1 PENDANT

Pendants

Design: Poul Henningsen

Concept: The fixture design is based on the principle of a reflective three-shade system, which directs the majority of the light downwards. The shades are made of hand-blown, opal, three-layer glass, which is glossy on top and sandblasted matte on the underside, giving a soft and uniform light distribution.

Finish: Black metalized or high lustre chrome plated. White opal glass.

Material: Shades: Handblown white opal glass (sandblasted on the undersides for uniform light distribution). Suspension: Black metalized or high lustre chrome plated, spun aluminum.

Mounting: Canopy: White. Cord type: 3-conductor, 18 AWG black PVC power cord. Cord length: 12'.

Weight: Max: 2 lbs.

Compliance: cULus, Dry location.

Info notes: Electrical:
 System Wattage: 10W
 LED Wattage: 9 W
 Delivered lumens: 286
 Efficacy: 28.6 lm/W

Certifications:
 cULus, Dry Location
 Protection class IP20
 Controllability: Phase dimming
 Actual performance dependent upon screw-base lamp used.



Product Code	Light source	Voltage	Finish	Cable type	Item number	Price
PH2/1-P	1x20W G16.5/IF candelabra	120V	Black Metalized	BLACK TEXTILE	5741925300	858
PH2/1-P	1x20W G16.5/IF candelabra	120V	Brass Metalized	WHITE TEXTILE	5741925575	858
PH2/1-P	1x20W G16.5/IF candelabra	120V	High Lustre Chrome Plated	BLACK TEXTILE	5741925588	822

PH 2-1 STEM FITTING

Pendants

Design: Poul Henningsen

Concept: The fixture is designed based on the principle of a reflective three-shade system, which directs the majority of the light downwards. The shades are made of handblown opal three-layer glass, which is glossy on the top and sandblasted matte on the underside, giving a soft and diffused light distribution.

Finish: High lustre chrome plated. White opal glass.

Material: Shades: Handblown white opal glass.
 Body: High lustre chrome plated, brass.
 Socket cover: High lustre chrome plated, spun aluminum.

Mounting: Canopy: White.
 Cord length: 12'.
 Cord type: 3-conductor, 18 AWG black braided fabric covered power cord.

Compliance: cULus, Dry location.

Info notes: Electrical:
 System Wattage: 30W
 Delivered lumens: 1,025
 Efficacy: 34 lm/W

Certifications:
 cULus, Dry Location
 Protection class IP20
 Controllability: Phase dimming
 Actual performance dependent upon screw-base lamp used.

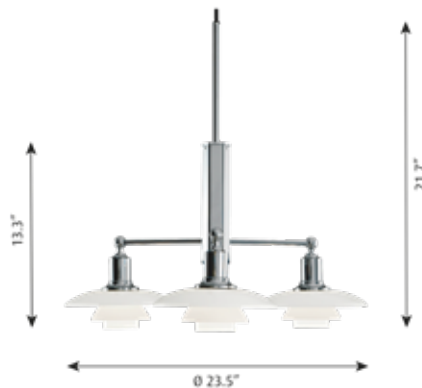

Product Code	Light source	Voltage	Finish	Cable type	Item number	Price
PH21-SF-P	3x10W G16.5/IF candelabra	120V	High Lustre Chrome Plated	BLACK TEXTILE	5741939590	2.868

PH 3/3 PENDANT

Pendants

Design: Poul Henningsen

Concept: The fixture emits a comfortable, diffused, glare-free light that is characteristic of Poul Henningsen’s reflective three-shade-system. The fixture is available with white opal glass or soft-touch black-painted metal with a white interior. The translucent shades in triple-layered, hand-blown opal glass create a warm glow around the pendant, whereas the metal shades with their white-painted interiors reflect a fine and primarily downwardly directed light. An optional translucent opal diffuser (included) is easy to insert for an even softer light distribution.

Finish: Shades: White opal glass or soft -touch black-painted with white interior.
Suspension: matte-black, powder-coated. **Canopy:** White.

Material: Shades: Mouth-blown white opal glass or spun aluminium.
 Bottom diffuser: Frosted glass.
 Suspension: Aluminium.
 Canopy: Aluminium.

Mounting: Canopy: White. Cord type: 2-conductor, 18 AWG black cloth-covered power cord. Cord length: 12 feet.

Compliance: cULus, Dry location.

Info notes: “Electrical:
 System Wattage: 15W LED
 Wattage: 14 W
 Delivered lumens: 1,364
 Efficacy: 90.9 lm/W
 Certifications: cULus, Dry Location
 Protection class IP20
 Controllability: Phase dimming
 Actual performance dependent upon screw-base lamp used.”



Light source	Finish	Shade	Cable type	Item number	Price
1x15W A-19/medium	Metal Black		BLACK TEXTILE	5741940424	1.412
1x15W A-19/medium	Metal Black/Opal Glass		BLACK TEXTILE	5741940437	1.448
1x15W A-19/medium	White Opal Glass	Glass	BLACK TEXTILE	5741940411	1.466
Sparepart					
PH 3-3 PENDANT LOWER SHADE U3 BLK METAL				5741106608	338
PH 3½-3, LOWER SHADE, GLASS				5741094781	356
PH 3-2 PENDANT, TOP SHADE, GLASS				5741085091	426
PH 3-3 PENDANT UPPER SHADE O3 BLK METAL				5741106585	428
PH 3-3 PENDANT MIDDLE SHADE M3 BLK METAL				5741106598	428
PH 3-3 PENDANT MIDDLE SHADE M3 GLASS				5741106572	466
PH 3-3/PH 5-5 PENDANT CANOPY V2				5741109498	Contact LP

PH 3½-3 GLASS PENDANT

Pendants

Design: Poul Henningsen

Concept: The fixture is designed based on the principle of a reflective three-shade system, which directs the majority of the light downwards. The shades are made of hand blown opal three-layer glass, which is glossy on top and sandblasted matte on the underside, giving a soft and uniform light distribution.

Finish: Black metalized or high lustre chrome plated. White opal glass.

Material: Shades: Hand blown white opal glass. Suspension: Black metalized or high lustre chrome plated, brass.

Mounting: Canopy: Black. Cord type: 3-conductor, 18 AWG black PVC power cord. Cord length: 12'.

Weight: Max: 5 lbs.

Compliance: cULus, Dry location.

Info notes: Electrical:
 System Wattage: 15W
 LED Wattage: 14 W
 Delivered lumens: 1,364
 Efficacy: 90.9 lm/W

Certifications:
 cULus, Dry Location
 Protection class IP20
 Controllability: Phase dimming
 Actual performance dependent upon screw-base lamp used.



Product Code	Light source	Voltage	Finish	Cable type	Item number	Price
PH 3 ½-3-P-G	1x15W A-19/medium	120V	Black Metalized	BLACK TEXTILE	5741919976	1.742
PH 3 ½-3-P-G	1x15W A-19/medium	120V	Brass Metalized	WHITE TEXTILE	5741919675	1.742
PH 3 ½-3-P-G	1x15W A-19/medium	120V	High Lustre Chrome Plated	BLACK TEXTILE	5741919989	1.654
Sparepart						
PH 3½-3, LOWER SHADE, GLASS					5741094781	356
PH 3½-3, MIDDLE SHADE, GLASS					5741094794	456
PH 3½-3 PENDANT TOP SHADE GLASS					5741099346	568

PH 3½-3 PENDANT

Pendants

Design: Poul Henningsen

Concept: The fixture is 100% glare-free, with a design based on the principle of a reflective three-shade system, which directs most of the light downwards. The shades are made of deep drawn aluminum with white inner surface that ensures gentle, downward light distribution. The downward light is both soft and pleasant.

Finish: Shade: red, green, yellow and white, powder coated. Suspension: silk matte brown, copper.

Material: Shades: deep drawn aluminum. Suspension: silk matte brown, copper.

Mounting: Canopy: White. Cord type: 3-conductor, 18 AWG white PVC power cord. Cord length: 12'.

Weight: Max: 6 lbs.

Compliance: cULus, Dry location.

Info notes: Electrical:

System Wattage: 15W

LED Wattage: 14 W

Delivered lumens: 1,364

Efficacy: 90.9 lm/W

Certifications: cULus, Dry Location

Protection class IP20

Controllability: Phase dimming

Actual performance dependent upon screw-base lamp used.



Product Code	Light source	Voltage	Finish	Cable type	Item number	Price
PH 3 ½-3-P	1x15W A-19/medium	120V	Green	WHITE TEXTILE	5741928653	1.430
PH 3 ½-3-P	1x15W A-19/medium	120V	Red	WHITE TEXTILE	5741928640	1.430
PH 3 ½-3-P	1x15W A-19/medium	120V	White	WHITE TEXTILE	5741928666	1.430
PH 3 ½-3-P	1x15W A-19/medium	120V	Yellow	WHITE TEXTILE	5741928637	1.430

PH 4¹/₂-4 GLASS PENDANT

Pendants

Design: Poul Henningsen

Concept: The fixture is designed based on the principle of a reflective three-shade system, which directs the majority of the light downwards. The shades are made of hand blown opal three-layer glass, which is glossy on top and sandblasted matte on the underside, giving a soft and uniform light distribution.

Finish: High lustre chrome plated. White opal glass.

Material: Shades: Hand blown white opal glass. Suspension: High lustre chrome plated, extruded aluminum.

Mounting: Canopy: White. Cord type: 3-conductor, 18 AWG black PVC power cord. Cord length: 12'.

Weight: Max: 12 lbs.

Compliance: cULus, Dry location.

Info notes: Electrical:
 System Wattage: 22W
 LED Wattage: 20 W
 Delivered lumens: 1,367
 Efficacy: 62.1 lm/W

Certifications:
 cULus, Dry Location
 Protection class IP20
 Controllability: Phase dimming
 Actual performance dependent upon screw-base lamp used.



Product Code	Light source	Voltage	Finish	Cable type	Item number	Price
PH4 ¹ / ₂ -4	1x22W A-21/medium	120V	High Lustre Chrome Plated	BLK	5741902381	3.680
Sparepart						
FINGER SCREW MCP M3X11 (3PCS) LOWER					5744611158	10

PH 5

Pendants

Design: Poul Henningsen

Concept: The fixture provides a comfortable, glare-free light based on the principle of Poul Henningsen's reflective three-shade system, which directs the majority of the light downward. It emits a lateral light as well as illuminating itself, providing a soft radiance from within its core.

The lower shade is fitted with a frosted-glass diffuser to ensure that the downwardly directed light is 100% glare-free.

Finish: White Classic or White Modern: Matt powder coated.

Monochrome Pale Rose, Monochrome Oyster Grey, Monochrome Black, Monochrome Blue or Monochrome White: Matt, wet painted.

Pastels Oyster Blue Rose or Pastels Blue Rose Peach: Matt wet painted.

Hues of Blue, Hues of Green, Hues of Grey, Hues of Orange, Hues of Red, Hues of Rose: Matt wet painted.

Metal variants: Polished Brass or Copper: Matt, powder coated.

Please note that the copper and brass surface is untreated. This means that the surface will change over time and develop a patina.

Material: Lower shade: Spun steel.

Other shades and anti-glare disc: Spun aluminium, spun copper or spun brass. Struts: Rolled aluminium.

Diffuser: Frosted glass.

Mounting: Canopy and cord: Black for Monochrome Black, White for all other colors.

Cord type: 3-conductor, 18 AWG cloth-covered power cord. Cord length: 12 feet.

Weight: Max. 2.5 kg.

Compliance: cULus, Damp location.

Info notes: Colour of anti-glare disc:

Blue: White Classic, Monochrome Blue and Hues of Orange.

Green: Hues of Red and Hues of Rose.

Red: Hues of Green and Hues of Blue.

Rose: Pastel Blue Rose Peach, Hues of Grey and White Modern.

Peach: Pastel Oyster Blue Rose.

Same colour/material as main shade on Monochrome and Metal variants.

Colour of struts:

Purple: White Classic.

Bronze coloured: White Modern and Hues of colours.

White: Copper, Brass and Pastels.

Same colour as main shade on Monochrome variants.

Cable and canopy: Monochrome Black: Black cable and canopy.

All others: White cable and canopy.

Please note that the copper and brass surface is untreated. This means that the surface will change over time and develop a patina. This process may have already begun when the product is delivered.

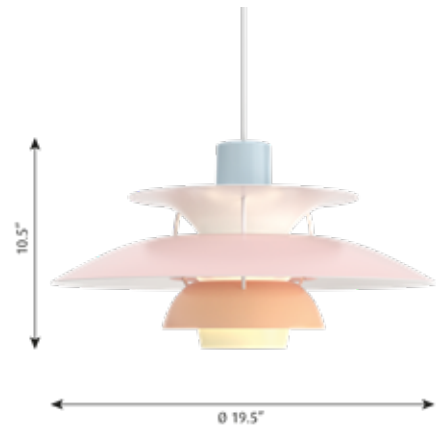

Product Code	Light source	Voltage	Finish	Cable type	Item number	Price
PH5	1x22W A-21/medium	120V	Brass	WHITE TEXTILE	5741919277	1.536
PH5	1x22W A-21/medium	120V	Copper	WHITE TEXTILE	5741918090	1.536
PH5	1x22W A-21/medium	120V	Hues of Blue	WHITE TEXTILE	5741918087	1.224
PH5	1x22W A-21/medium	120V	Hues of Green	WHITE TEXTILE	5741918074	1.224
PH5	1x22W A-21/medium	120V	Hues of Grey	WHITE TEXTILE	5741918045	1.224
PH5	1x22W A-21/medium	120V	Hues of Orange	WHITE TEXTILE	5741918058	1.224

Product Code	Light source	Voltage	Finish	Cable type	Item number	Price
PH5	1x22W A-21/medium	120V	Hues of Red	WHITE TEXTILE	5741918061	1.224
PH5	1x22W A-21/medium	120V	Hues of Rose	WHITE TEXTILE	5741918032	1.224
PH5	1x22W A-21/medium	120V	Monochrome Oyster Grey	WHITE TEXTILE	5741940097	1.224
PH5	1x22W A-21/medium	120V	Monochrome Pale Rose	WHITE TEXTILE	5741940042	1.224
PH5	1x22W A-21/medium	120V	Pastels Blue Rose Peach	WHITE TEXTILE	5741940149	1.224
PH5	1x22W A-21/medium	120V	Pastels Oyster Blue Rose	WHITE TEXTILE	5741940194	1.224
PH5	1x22W A-21/medium	120V	White Classic	WHITE TEXTILE	5741918113	1.224
PH5	1x22W A-21/medium	120V	White Modern	WHITE TEXTILE	5741918100	1.224
Sparepart						
PH5 PLUS/PH50 GLASS DISC					5741093300	28
PH 5 (CLASSIC) SPACERS (1 SET)					5741093407	84
PH 5 SPACERS PAINTED BRONZE (1 SET)					5741100235	84
PH 5 SPACERS PAINTED WHITE (1 SET)					5741100248	84
PH 5 SPACERS MONOCHROME WHITE (1 SET)					5741106093	84
PH 5 SPACERS MONOCHROME BLUE (1 SET)					5741106103	84
PH 5 SPACERS MONOCHROME BLACK (1 SET)					5741106116	84

PH 5 MINI

Pendants

Design: Poul Henningsen

Concept: The fixture provides 100% glare-free light. Its design is based on the principle of a reflective three-shade system that directs most of the light downward. The fixture emits both downward and lateral light, thus illuminating itself.

Finish: Classic (white) or Modern White: Matte powder-coated.

Monochrome Black, Monochrome Blue, Monochrome White, Hues of Blue, Hues of Green, Hues of Gray, Hues of Orange, Hues of Red, Hues of Rose: Matte wet-painted.

Metal versions: Polished brass or copper and white, matte powder-coated. Please note that the copper and brass surfaces are untreated. This means that the surfaces will change over time and develop a patina.

Material: Shades and anti-glare disc: Spun aluminum, spun copper or spun brass. Struts: rolled aluminum.

Mounting: Canopy and cord: Black for Monochrome Black, White for all other colors. Cord type: 3-conductor, 18 AWG cloth-covered power cord. Cord length: 12 feet.

Weight: Max. 0.9 kg.

Compliance: cULus, Damp location.

Info notes: Electrical:
 System Wattage: 6W
 LED Wattage: 6 W
 Delivered lumens: 156 - 142
 Efficacy: 26.0 lm/W - 23.7 lm/W

Certifications:
 cULus, Damp Location
 Protection class IP20
 Controllability: Phase dimming
 Actual performance dependent upon screw-base lamp used.

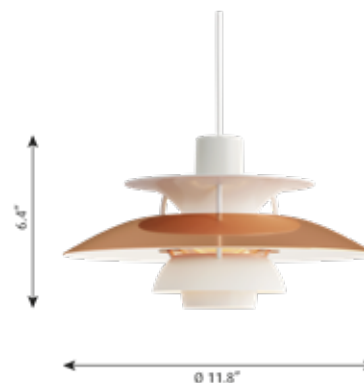

Product Code	Light source	Voltage	Finish	Cable type	Item number	Price
PH 5 MINI	1x10W A-15/medium	120V	Brass	WHT	10000147590	1.198
PH 5 MINI	1x10W A-15/medium	120V	Copper	WHITE TEXTILE	5741918223	1.198
PH 5 MINI	1x10W A-15/medium	120V	Hues of Blue	WHITE TEXTILE	10000142114	886
PH 5 MINI	1x10W A-15/medium	120V	Hues of Green	WHITE TEXTILE	10000142115	886
PH 5 MINI	1x10W A-15/medium	120V	Hues of Grey	WHITE TEXTILE	10000142116	886
PH 5 MINI	1x10W A-15/medium	120V	Hues of Orange	WHITE TEXTILE	10000142117	886
PH 5 MINI	1x10W A-15/medium	120V	Hues of Red	WHITE TEXTILE	10000142118	886
PH 5 MINI	1x10W A-15/medium	120V	Hues of Rose	WHITE TEXTILE	10000142119	886
PH 5 MINI	1x10W A-15/medium	120V	White Classic	WHITE TEXTILE	10000142110	886
PH 5 MINI	1x10W A-15/medium	120V	White Modern	WHITE TEXTILE	10000142113	886

PH 5/5 PENDANT

Pendants

Design: Poul Henningsen

Concept: The fixture emits a comfortable, diffused, glare-free light that is characteristic of Poul Henningsen’s reflective three-shade-system. The fixture is available with white opal glass or soft-touch black-painted metal with a white interior. The translucent shades in triple-layered, hand-blown opal glass create a warm glow around the pendant, whereas the metal shades with their white-painted interiors reflect a fine and primarily downwardly directed light. An optional translucent white diffuser (included) is easy to insert for an even softer light distribution.

Finish: Shades: White opal glass or soft -touch black-painted with white interior.
Suspension: matte-black, powder-coated. **Canopy:** White.

Material: Shades: Hand-blown white opal glass or spun aluminum. Bottom diffuser: Frosted glass. **Suspension:** aluminum.

Mounting: Canopy: White. Cord type: 2-conductor, 18 AWG black cloth-covered power cord. Cord length: 12 feet. Incandescent variants have a canopy of flat cone profile, 5.3 IN diameter x 1 IN tall. LED variants have a canopy of dome profile, 9.4 IN diameter x 4.3 IN tall. LED variants have an electronic, constant current, class II driver for 120-277V power supply housed inside canopy.



Compliance: cULus, Dry location.

Info notes: Electrical:

System Wattage: 22W (INC) or 41W (LED)
 LED Wattage: 20W (INC) or 39W (LED)
 Delivered lumens: 1,187 (INC) - 2,297 (LED)
 Efficacy: 56- 29 lm/W
 Certifications: cULus, Dry Location
 Protection class IP20
 Controllability: Phase dimming or 0-10V dimming.
 LED Color Rendering: Ra≥90
 Dim-To-Warm LED CCT: 3000K (100%) to 1800K (5%)

Light source	Finish	Cable type	Item number	Price
1x22W A-21/medium	Metal Black	BLACK TEXTILE	5741940521	1.930
1x22W A-21/medium	Metal Black/Opal Glass	BLACK TEXTILE	5741940534	2.118
Sparepart				
PH 5-5 PENDANT UPPER SHADE 05 BLK METAL			5741106666	1.160
PH 5-5 PEND LED DIFFUSER SHIELD			5741106734	14
PH 5-5 PENDANT SHADEHOLDER BLK METAL			5741106695	188
PH 5-5 PENDANT SHADEHOLDER BLK METAL V2			5741109469	188
PH 5-5 PENDANT SHADEHOLDER LED BLK METAL			5741106705	206
PH 5-5 PENDANT SHADEHOLD LED BLK MET V2			5741109472	206
PH 5-5 PENDANT LOWER SHADE U5 BLK METAL			5741106682	624
PH 5-5 PENDANT LOWER SHADE U5 GLASS			5741106653	642
PH 5-5 PENDANT MIDDLE SHADE M5 BLK METAL			5741106679	882
PH 5-5 PENDANT MIDDLE SHADE M5 GLASS			5741106640	900
PH 5-5 PEND SHADE SCREW W NUT BLK (3PCS)			5741106718	Contact LP
PH 5-5 PEND LED REPL KIT 27K			5741108839	Contact LP
PH 5-5 PEND LED REPL KIT 3K			5741108842	Contact LP
PH 5-5 PEND LED REPL KIT D2W			5741108855	Contact LP
PH 5-5 PEND SHADE SCREW W NUT BLK 3PC V2			5741109485	Contact LP
PH 3-3/PH 5-5 PENDANT CANOPY V2			5741109498	Contact LP

PH 5-4½ & PH 6½-6

Pendants

Design: Poul Henningsen

Concept: The trumpet-shaped top shade provides illumination of the area above the three lower shades, which primarily direct the light downwards. A base reflector and a blue glare ring protect against glare from all angles. The strongest light is directly under the fixture. The shades have a matte white painted finish to ensure very comfortable lighting.

Finish: White.

Material: Shades: Spun aluminum. Struts: Rolled aluminum.

Mounting: Suspension type: 1x stainless steel aircraft cable (PH 6½-6). Canopy: White. Cord type: 3-conductor, 18 AWG white PVC power cord. Cord length: 12'.

Weight: Max: 21 lbs.

Compliance: cULus, Damp location.

Info notes: Electrical:

System Wattage: 22 W - 96 W

LED Wattage: 20 W - 94 W

Delivered lumens: 1,645 - 4,420

Efficacy: 46.0 - 74.7 lm/W

Certifications:

cULus, Damp Location

Protection class IP20

Controllability: Phase dimming or 0-10V dimming.

Color Rendering: Ra≥90 for LED variants.



Product Code	Dimensions	Light source	Voltage	Finish	Cable type	Lighting control	Item number	Price
PHC-P	5-4½	1x22W A-21/medium	120V	White	WHT		5741907768	Contact LP
PHC-P	5-4½	44W LED/3000-1800K D2W	120-277V/60HZ	White	WHITE TEXTILE	DIM 0-10V	10000149869	3.862
PHC-P	5-4½	44W LED/3000-1800K D2W	120V	White	WHITE TEXTILE	PHASE DIMMING (MAINS DIMM)	10000149870	3.862
PHC-P	5-4½	44W LED/3000K	120-277V/60HZ	White	WHITE TEXTILE	DIM 0-10V	10000149867	3.862
PHC-P	5-4½	44W LED/3000K	120V	White	WHITE TEXTILE	PHASE DIMMING (MAINS DIMM)	10000149868	3.862
PHC-P	6½-6	96W LED/2700K	120-277V/60HZ	White	WHITE TEXTILE	DIM 0-10V	5741928695	6.180
PHC-P	6½-6	96W LED/3000K	120-277V/60HZ	White	WHITE TEXTILE	DIM 0-10V	5741938698	6.180
Sparepart								
BOTTOM ASSEMBLY COMPLETE PH 5-4½							5741481815	490

PH ARTICHOKE

Pendants

Design: Poul Henningsen

Concept: The fixture provides 100% glare-free light. The 72 precisely positioned leaves form 12 unique rows of six leaves each. They illuminate the fixture as well as emitting diffused light with a unique pattern. The fixture provides decorative and comfortable lighting. For the energy saving LED variant, the quality of light and atmosphere surrounding the product is kept at the highest level.

Finish: Brass, copper or stainless steel, brushed and coated.
Black, powder coated with white, wet painted inner side.
White, wet painted.

Material: Leaves: Punched brass, punched copper or laser cut stainless steel.
Top shade: White, spun steel.
Frame: High luster chrome plated, laser cut steel.
Suspension: High lustre chrome plated, spun aluminum.

Mounting: Mounting: Suspension type: 3x stainless steel aircraft cables. Suspension length: 12'. Canopy: White. Cord type: 3-conductors (non-LED) / 2-conductors (LED), 18 AWG white PVC power cord. Cord color: white cord. Cord length: 12'.

Weight: Max: 61 lbs.

Compliance: cULus, Damp location.

Info notes: Electrical:

System Wattage: 96W (LED); 200W (INC)
LED Wattage: 184 W or 88 W
Delivered lumens: 615 - 3,681
Efficacy: 3.1 lm/W - 38.3 lm/W

Certifications:

cULus, Damp Location
Protection class IP20
Controllability: 0-10V Dimming (LED variants); Phase dimming (incandescent variants)
Color Rendering: Ra≥90 for LED variants.
Performance dependent upon screw-base lamp used in socketed variants.



Product Code	Dimensions	Light source	Voltage	Finish	Cable type	Lighting control	Item number	Price
PHA	18.9 IN	1x200W A-23/CL medium	120V	Copper	WHT		6149904759	15.246
PHA	18.9 IN	1x200W A-23/CL medium	120V	Stainless Steel	WHT		5847901266	15.246
PHA	18.9 IN	1x200W A-23/CL medium	120V	White	WHT		5847901263	15.246
PHA	18.9 IN	1x200W A-23W/IF medium	120V	Black	WHT		10000146919	15.246
PHA	18.9 IN	1x200W A-23W/IF medium	120V	Brass	WHT		10000144752	15.246
PHA	18.9 IN	44W LED/3000-1800K D2W	120-277V/60HZ	Black	WHT	DIM 0-10V	10000151300	15.910
PHA	18.9 IN	44W LED/3000-1800K D2W	120V	Black	WHT	PHASE DIMMING (MANS DIMM)	10000151301	15.910
PHA	18.9 IN	44W LED/3000-1800K D2W	120-277V/60HZ	Brass	WHT	DIM 0-10V	10000149886	15.910
PHA	18.9 IN	44W LED/3000-1800K D2W	120V	Brass	WHT	PHASE DIMMING (MANS DIMM)	10000149891	15.910
PHA	18.9 IN	44W LED/3000-1800K D2W	120-277V/60HZ	Copper	WHT	DIM 0-10V	10000149887	15.910
PHA	18.9 IN	44W LED/3000-1800K D2W	120V	Copper	WHT	PHASE DIMMING (MANS DIMM)	10000149892	15.910
PHA	18.9 IN	44W LED/3000-1800K D2W	120-277V/60HZ	Stainless Steel	WHT	DIM 0-10V	10000149885	15.910
PHA	18.9 IN	44W LED/3000-1800K D2W	120V	Stainless Steel	WHT	PHASE DIMMING (MANS DIMM)	10000149890	15.910
PHA	18.9 IN	44W LED/3000-1800K D2W	120-277V/60HZ	White	WHT	DIM 0-10V	10000149889	15.910
PHA	18.9 IN	44W LED/3000-1800K D2W	120V	White	WHT	PHASE DIMMING (MANS DIMM)	10000149894	15.910
PHA	18.9 IN	44W LED/3000K	120-277V/60HZ	Black	WHT	DIM 0-10V	10000151298	15.910
PHA	18.9 IN	44W LED/3000K	120-277V/60HZ	Brass	WHT	DIM 0-10V	10000149876	15.910
PHA	18.9 IN	44W LED/3000K	120-277V/60HZ	Copper	WHT	DIM 0-10V	10000149877	15.910
PHA	18.9 IN	44W LED/3000K	120-277V/60HZ	Stainless Steel	WHT	DIM 0-10V	10000149875	15.910
PHA	18.9 IN	44W LED/3000K	120-277V/60HZ	White	WHT	DIM 0-10V	10000149879	15.910
PHA	23.6 IN	96W LED/2700K	120-277V/60HZ	Black	WHT	DIM 0-10V	10000151297	19.254
PHA	23.6 IN	96W LED/2700K	120-277V/60HZ	Copper	WHT	DIM 0-10V	10000130395	19.254

Product Code	Dimensions	Light source	Voltage	Finish	Cable type	Lighting control	Item number	Price
PHA	23.6 IN	96W LED/2700K	120-277V/60HZ	Stainless Steel	WHT	DIM 0-10V	10000130393	19.254
PHA	23.6 IN	96W LED/2700K	120-277V/60HZ	White	WHT	DIM 0-10V	10000130396	19.254
PHA	23.6 IN	96W LED/3000K	120-277V/60HZ	Black	WHT	DIM 0-10V	10000146921	19.254
PHA	23.6 IN	96W LED/3000K	120-277V/60HZ	Copper	WHT	DIM 0-10V	10000130399	19.254
PHA	23.6 IN	96W LED/3000K	120-277V/60HZ	Stainless Steel	WHT	DIM 0-10V	10000130397	19.254
PHA	23.6 IN	96W LED/3000K	120-277V/60HZ	White	WHT	DIM 0-10V	10000130400	19.254
PHA	28.3 IN	96W LED/2700K	120-277V/60HZ	Black	WHT	DIM 0-10V	10000146922	21.396
PHA	28.3 IN	96W LED/2700K	120-277V/60HZ	Copper	WHT	DIM 0-10V	10000141076	21.396
PHA	28.3 IN	96W LED/2700K	120-277V/60HZ	Stainless Steel	WHT	DIM 0-10V	10000141065	21.396
PHA	28.3 IN	96W LED/2700K	120-277V/60HZ	White	WHT	DIM 0-10V	10000141079	21.396
PHA	28.3 IN	96W LED/3000K	120-277V/60HZ	Black	WHT	DIM 0-10V	10000146923	21.396
PHA	28.3 IN	96W LED/3000K	120-277V/60HZ	Copper	WHT	DIM 0-10V	10000128781	21.396
PHA	28.3 IN	96W LED/3000K	120-277V/60HZ	Stainless Steel	WHT	DIM 0-10V	10000128780	21.396
PHA	28.3 IN	96W LED/3000K	120-277V/60HZ	White	WHT	DIM 0-10V	10000128782	21.396
PHA	33.1 IN	96W LED/2700K	120-277V/60HZ	Black	WHT	DIM 0-10V	10000146924	23.536
PHA	33.1 IN	96W LED/2700K	120-277V/60HZ	Copper	WHT	DIM 0-10V	10000141082	23.536
PHA	33.1 IN	96W LED/2700K	120-277V/60HZ	Stainless Steel	WHT	DIM 0-10V	10000141080	23.536
PHA	33.1 IN	96W LED/2700K	120-277V/60HZ	White	WHT	DIM 0-10V	10000141084	23.536
PHA	33.1 IN	96W LED/3000K	120-277V/60HZ	Black	WHT	DIM 0-10V	10000146925	23.536
PHA	33.1 IN	96W LED/3000K	120-277V/60HZ	Copper	WHT	DIM 0-10V	10000128784	23.536
PHA	33.1 IN	96W LED/3000K	120-277V/60HZ	Stainless Steel	WHT	DIM 0-10V	10000128783	23.536
PHA	33.1 IN	96W LED/3000K	120-277V/60HZ	White	WHT	DIM 0-10V	10000128785	23.536
Sparepart								
PH ART 600 SUSP LED-D 27K90 US							5741917499	3.774
PH ART 600 SUSP LED-D 3K90 US							5741917509	3.774
PH ART 720/840 SUSP LED-D 3K90 US							5741917570	3.774

PH ARTICHOKE GLASS

Pendants

Design: Poul Henningsen

Concept: The fixture provides 100% glare-free light. The 72 precisely positioned leaves form 12 unique rows of six leaves each. They illuminate the fixture, as well as emit diffused light with a unique pattern. Reflection from the light source is diffused in the sandblasted lower surfaces, and this light is reflected decoratively in the top surfaces, giving the fixture a unique glow. The surface treatment on the glass leaves eliminates direct glare. For the energy saving LED variant, the quality of light and atmosphere surrounding the product is kept at the highest level.

Finish: Clear glass, sandblasted.

Material: Leaves: Clear glass, sandblasted. Top shade: High lustre chrome plated or white, spun brass. Frame: High lustre chrome plated, laser cut brass. Suspension: High lustre chrome plated, spun aluminum.

Mounting: Mounting: Suspension type: 3x stainless steel aircraft cables. Suspension length: 12'. Canopy: White. Cord type: 3-conductors (non-LED) / 2-conductors (LED), 18 AWG white PVC power cord. Cord color: white cord, except for copper non-LED variants have black cord. Cord length: 12'.

Weight: Max: 72 lbs.

Compliance: cULus, Damp location.

Info notes: Electrical:

System Wattage: 96W (LED); 200W (INC)

LED Wattage: 184 W or 88 W

Delivered lumens: 2,243 - 7,762

Efficacy: 11.2 lm/W - 80.9 lm/W

Certifications:

cULus, Dry Location

Protection class IP20

Controllability: 0-10V Dimming (LED variants); Phase dimming (incandescent variants)

Color Rendering: Ra≥90 for LED variants.

Performance dependent upon screw-base lamp used in socketed variants.



Product Code	Dimensions	Light source	Voltage	Finish	Cable type	Lighting control	Item number	Price
PHA-P-G	18.9 IN	1x200W A-23/CL medium	120V	Clear Glass Sandblasted	WHT		5847901441	45.292
PHA-P-G	23.6 IN	59W LED/2700K	120-277V/60HZ	Clear Glass Sandblasted	WHT	DIM 0-10V	10000130401	54.282
PHA-P-G	23.6 IN	59W LED/3000K	120-277V/60HZ	Clear Glass Sandblasted	WHT	DIM 0-10V	10000130402	54.282
PHA-P-G	28.3 IN	96W LED/2700K	120-277V/60HZ	Clear Glass Sandblasted	WHT	DIM 0-10V	10000141085	62.800
PHA-P-G	28.3 IN	96W LED/3000K	120-277V/60HZ	Clear Glass Sandblasted	WHT	DIM 0-10V	10000128777	62.800
PHA-P-G	33.1 IN	96W LED/2700K	120-277V/60HZ	Clear Glass Sandblasted	WHT	DIM 0-10V	10000141086	71.202
PHA-P-G	33.1 IN	96W LED/3000K	120-277V/60HZ	Clear Glass Sandblasted	WHT	DIM 0-10V	10000128778	71.202
Sparepart								
PH ART 600 GLASS SUSP LED-D 27K90 US							5741917538	3.774
PH ART 600 GLASS SUSP LED-D 3K90 US							5741917541	3.774
PH ART 720/840 SUSP LED-D 3K90 US							5741917570	3.774

PH LOUVRE

Pendants

Design: Poul Henningsen

Concept: The fixture provides 100% glare-free light. The geometrical, spherical design is based on the principle of illuminating all surfaces at the same angle. This ensures uniform light around the fixture, illuminating both walls and ceiling. Matte painted undersurfaces and glossy top surfaces result in an attractive reflection of the diffused light, creating uniform light distribution around the fixture.

Finish: White, wet painted.

Material: Shades: Spun aluminum. Frame: High lustre chrome plated, extruded brass. Housing: High lustre chrome plated, spun aluminum.

Mounting: Suspension type: 1x stainless steel aircraft cable. Canopy: White. Cord type: 3-conductor, 18 AWG white PVC power cord. Cord length: 12'.

Weight: Max: 26 lbs.

Compliance: cULus, Damp location.

Info notes: Electrical:
 System Wattage: 97W
 LED Wattage: 89 W
 Delivered lumens: 2,479 - 2,596
 Efficacy: 25.6 lm/W - 26.8 lm/W

Certifications:
 cULus, Dry Location
 Protection class IP20
 Controllability: 0-10V Dimming
 Color Rendering: Ra≥90



Product Code	Light source	Voltage	Finish	Cable type	Lighting control	Item number	Price
PHL	97W LED/2700K	120-277V/60HZ	White	WHT	DIM 0-10V	5741917910	12.786
PHL	97W LED/3000K	120-277V/60HZ	White	WHT	DIM 0-10V	5741917923	12.786

PH SEPTIMA

Pendants

Design: Poul Henningsen

Concept: The seven-shade glass crown emits a glare-free, downwardly directed light while radiating a pleasantly delicate glow. Frosted glass fields alternately cover the clear ones from shade-to-shade, thus diffusing the light even more softly.

Finish: Clear glass with sandblasted fields. Untreated satin-polished brass.

Material: Shades: Clear glass with sandblasted fields. Legs: Steel, metallized brass. Socket housing and canopy: Untreated satin-polished brass. Please note that the brass surface is untreated. The untreated brass will change over time and develop a patina.

Mounting: 1x stainless steel aircraft cable. Canopy: Untreated brass. Cord type: 3-conductor, 18 AWG white braided fabric covered power cord. Cord length: 12'.

Weight: Max. 7 kg

Compliance: cULus, Dry location.

Info notes: Electrical:
 System Wattage: 22W
 LED Wattage: 20 W
 Delivered lumens: 2,452
 Efficacy: 111 lm/W

Certifications:
 cULus, Dry Location
 Protection class IP20
 Controllability: Phase dimming
 Actual performance dependent upon screw-base lamp used.



Light source	Finish	Cable type	Item number	Price
1x22W E26	Clear and Matte Glass/Brass	WHITE TEXTILE	5741934508	16.758

PH SNOWBALL

Pendants

Design: Poul Henningsen

Concept: The fixture emits comfortable glare-free diffused light. Matte painted undersurfaces and glossy top surfaces result in an attractive reflection of the diffused light, creating uniform light distribution around the fixture. When the light is switched on, the top portion is illuminated while the bottom part remains dark.

Finish: White, wet painted.

Material: Shades: Spun aluminum. Frame: High lustre chrome plated, cast aluminum. Housing: High lustre chrome plated, spun aluminum.

Mounting: Canopy: White. Cord type: 3-conductor, 18 AWG white PVC power cord. Cord length: 12'.

Weight: Max: 8 lbs.

Compliance: cULus, Dry location.

Info notes: Electrical:
 System Wattage: 22W - 44W
 LED Wattage: 20 W - 42 W
 Delivered lumens: 894 - 1,085 lm
 Efficacy: 24.6 - 40.6 lm/W

Certifications:
 cULus, Dry Location
 Protection class IP20
 Controllability: Phase dimming or 0-10V dimming.
 Color Rendering: Ra≥90 for LED variants.
 Performance dependent upon screw-base lamp used in socketed variants.



Product Code	Light source	Voltage	Finish	Cable type	Lighting control	Item number	Price	
PHS	1x22W A-21/medium	120V	White	WHITE TEXTILE		5741928572	4.078	
PHS	44W LED/3000-1800K D2W	120-277V/60HZ	White	WHITE TEXTILE	DIM 0-10V	10000149873	4.722	
PHS	44W LED/3000-1800K D2W	120V	White	WHITE TEXTILE	PHASE DIMMING (MAINS DIMM)	10000149874	4.722	
PHS	44W LED/3000K	120-277V/60HZ	White	WHITE TEXTILE	DIM 0-10V	10000149871	4.722	
PHS	44W LED/3000K	120V	White	WHITE TEXTILE	PHASE DIMMING (MAINS DIMM)	10000149872	4.722	
Sparepart								
PH SNOWBALL, BOTTOMSHADE COMPLETE						5741086456	260	

TOLDBOD 6.1/8.7 GLASS PENDANT

Pendants

Design: Louis Poulsen A/S

Concept: The fixture emits glare-free light directed primarily downwards. The opal glass provides a comfortable and uniform illumination of the area around the fixture.

Finish: White opal glass.

Material: Suspension: Brushed stainless steel. Shade: Handblown white opal glass.

Mounting: Canopy: White. Cord type: 3-conductor, 18 AWG white PVC power cord. Cord length: 12'.

Weight: Max: 4 lbs.

Compliance: cULus, Dry location.

Info notes: Electrical:

System Wattage: 5W or 22W

LED Wattage: 5 W or 20 W

Delivered lumens: 189 - 436

Efficacy: 37.8 lm/W - 19.8 lm/W

Certifications:

cULus, Dry Location

Protection class IP20

Controllability: Phase dimming

Actual performance dependent upon screw-base lamp used.



Product Code	Dimensions	Light source	Voltage	Finish	Item number	Price
TOP	6.1 IN	1x10W G16.5/IF candelabra	120V	White Opal Glass	604000008	618
TOP	8.7 IN	1x22W A-21/medium	120V	White Opal Glass	10000124350	778

TOLDBOD PENDANT

Pendants

Design: Louis Poulsen A/S

Concept: The pendant emits soft downwards directed light. The matte, white-painted inside of the elliptical shade helps to assure even distribution of the light.

Finish: Ø4.7"/Ø6.7"/Ø9.8": Black, White, Dark Rose, Light Grey or Blue-Grey. Matte powder coated. Ø14.7"/Ø21.7": Black or White. Matte powder coated.

Material: Shade: Spun aluminum. Ø4.7" reflector: Spun white matte coated aluminum. Ø14.7"/Ø21.7" diffusor: Matte acrylic

Mounting: Canopy: White. Cord type: 18 AWG fabric covered power cord. Black cord for black, dark rose, and blue-grey pendants, white cord for white and light grey pendants. Ø14.7"/Ø21.7" come with 1x stainless steel aircraft cable. Cord length: 12'.

Weight: Max: 2 lbs.

Compliance: cULus, Dry location.

Info notes: Electrical:
 System Wattage: 4W or 22W
 LED Wattage: 4 W or 20 W
 Delivered lumens: 287 - 1,845
 Efficacy: 71.8 lm/W - 83.9 lm/W

Certifications:
 cULus, Dry Location
 Protection class IP20
 Controllability: Phase dimming
 Actual performance dependent upon screw-base lamp used.



Product Code	Dimensions	Light source	Voltage	Finish	Cable type	Item number	Price
TOL-120-P	15.7 IN	1x15W A-19/medium	120V	Black	BLACK TEXTILE	10000149819	1.030
TOL-120-P	15.7 IN	1x15W A-19/medium	120V	White	WHITE TEXTILE	10000149820	1.030
TOL-120-P	21.7 IN	1x22W A-21/medium	120V	Black	BLACK TEXTILE	10000149821 *	1.380
TOL-120-P	21.7 IN	1x22W A-21/medium	120V	White	WHITE TEXTILE	10000149822 *	1.380
TOL-120-P	4.7 IN	1x4W T-4 G9	120V	Black	BLACK TEXTILE	10000149900	458
TOL-120-P	4.7 IN	1x4W T-4 G9	120V	Blue-Grey	BLACK TEXTILE	10000149902	458
TOL-120-P	4.7 IN	1x4W T-4 G9	120V	Dark Rose	BLACK TEXTILE	10000149903 *	458
TOL-120-P	4.7 IN	1x4W T-4 G9	120V	Light Grey	WHITE TEXTILE	10000149901	458
TOL-120-P	4.7 IN	1x4W T-4 G9	120V	White	WHITE TEXTILE	10000149904	458
TOL-120-P	6.7 IN	1x10W G16.5/candelabra	120V	Black	BLACK TEXTILE	10000149809	478
TOL-120-P	6.7 IN	1x10W G16.5/candelabra	120V	Blue-Grey	BLACK TEXTILE	10000149811	478
TOL-120-P	6.7 IN	1x10W G16.5/candelabra	120V	Dark Rose	BLACK TEXTILE	10000149812 *	478
TOL-120-P	6.7 IN	1x10W G16.5/candelabra	120V	Light Grey	WHITE TEXTILE	10000149810	478
TOL-120-P	6.7 IN	1x10W G16.5/candelabra	120V	White	WHITE TEXTILE	10000149813	478
TOL-120-P	9.8 IN	1x10W A-15/medium	120V	Black	BLACK TEXTILE	10000149814	654
TOL-120-P	9.8 IN	1x10W A-15/medium	120V	Blue-Grey	BLACK TEXTILE	10000149816	654
TOL-120-P	9.8 IN	1x10W A-15/medium	120V	Dark Rose	BLACK TEXTILE	10000149817 *	654
TOL-120-P	9.8 IN	1x10W A-15/medium	120V	Light Grey	WHITE TEXTILE	10000149815	654
TOL-120-P	9.8 IN	1x10W A-15/medium	120V	White	WHITE TEXTILE	10000149818	654

*Available while stocks last

VL RING CROWN 1

Pendants

Design: Vilhelm Lauritzen

Concept: The pendant emits light directed primarily downwards. The opal glass provides a comfortable and uniform illumination of the area around the fixture.

Finish: Glossy, hand blown white opal glass. Satin polished brass, untreated.

Material: Shades: Hand blown, 3-layered, polished opal glass. Suspension: Untreated brass, will patinate.

Mounting: Mounting: Canopy: White. Cord type: 2-conductor, 18 AWG cloth-covered power cord. Cord length: 12 feet.

Compliance: Compliance: cULus, Dry location.

Info notes: Electrical:
 System Wattage: 15W
 LED Wattage: 14 W
 Delivered lumens: 936
 Efficacy: 62.4 lm/W -

Certifications:
 cULus, Dry Location
 Protection class IP20
 Controllability: Phase dimming
 Actual performance dependent upon screw-base lamp used.



Light source	Voltage	Finish	Cable type	Item number	Price
1x40W A-19/ medium US	120V	Brass/Glossy Opal Glass	WHITE TEXTILE	5741925423	706

VL RING CROWN 3-5-7

Pendants

Design: Vilhelm Lauritzen

Concept: The pendant emits light directed primarily downwards. The opal glass provides a comfortable and uniform illumination of the area around the fixture.

Finish: Glossy, hand blown white opal glass. Satin polished brass, untreated.

Material: Shades: Hand blown, 3-layered, polished opal glass. Wires: Stainless steel. Frame and canopy in untreated brass, will patinate.

Mounting: Mounting: Suspension type: 3x stainless steel aircraft cables. Suspension length: 12'. Canopy: Brass. Cord type: 3-conductors, 18 AWG white braided fabric covered cord. Cord length: 12'.

Weight: Min: 11.96 lbs Max: 22.28 lbs

Compliance: Compliance: cULus, Dry location.

Info notes: Electrical:

System Wattage: 45W or 105W

LED Wattage: 41 W or 97 W

Delivered lumens: 1,808 - 6,500

Efficacy: 40.2 lm/W - 61.9 lm/W

Certifications:

cULus, Dry Location

Protection class IP20

Controllability: Phase dimming

Actual performance dependent upon screw-base lamp used.

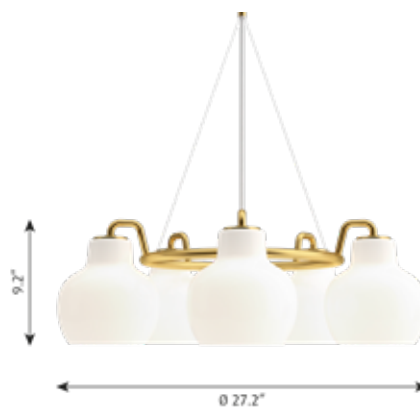

Dimensions	Light source	Voltage	Finish	Cable type	Item number	Price
3	3x40W A-19/ medium US	120V	Brass/Glossy Opal Glass	WHITE TEXTILE	5741925449	4.414
5	5x40W A-19/medium	120V	Brass/Glossy Opal Glass	WHITE TEXTILE	5741925465	5.650
7	7x40W A-19/medium	120V	Brass/Glossy Opal Glass	WHITE TEXTILE	5741925481	6.842
Sparepart						
VL RING CROWN WALL/3-5-7 GLASS					5741094406	494
VL RING CROWN CANOPY					5741094451	742

VL45 RADIOHUS PENDANT

Pendants

Design: Vilhelm Lauritzen

Concept: The fixture provides uniform, general and diffuse illumination. The opening at the bottom of the glass produces downwards directed light. The quality of the glass ensures that the fixture is evenly lit.

Finish: Glossy white opal glass. Brushed brass, untreated.

Material: Shade: Hand blown polished white opal glass. Pendant fitting: Untreated brushed brass, will patinate.

Mounting: Canopy: White. Cord type: 2-conductor, 18 AWG white braided fabric covered power cord. Cord length: 12'.

Weight: Max. : 9 lbs.

Compliance: cULus, Damp location.

Info notes: Electrical:

System Wattage: 10W - 44W

LED Wattage: 9 W or 42 W

Delivered lumens: 440 - 2,711

Efficacy: 44.0 lm/W - 123.2 lm/W

Certifications:

cULus, Dry Location

Protection class IP20

Controllability: 0-10V Dimming (LED variants); Phase dimming (incandescent variants)

Color Rendering: Ra≥90 for LED variants.

Performance dependent upon screw-base lamp used in socketed variants.



Product Code	Dimensions	Light source	Voltage	Finish	Cable type	Lighting control	Item number	Price
VL-45-P	14.6 IN	1x22W A-21/medium	120V	Brass/Glossy Opal Glass	WHITE TEXTILE		5741928527	1.062
VL-45-P	14.6 IN	44W LED/3000-1800K D2W	120V	Brass/Glossy Opal Glass	WHITE TEXTILE	DIM 0-10V	10000149833	1.696
VL-45-P	14.6 IN	44W LED/3000-1800K D2W	120V	Brass/Glossy Opal Glass	WHITE TEXTILE	PHASE DIMMING (MANS DIMM)	10000149834	1.696
VL-45-P	14.6 IN	44W LED/3000K	120V	Brass/Glossy Opal Glass	WHITE TEXTILE	DIM 0-10V	10000149831	1.696
VL-45-P	14.6 IN	44W LED/3000K	120V	Brass/Glossy Opal Glass	WHITE TEXTILE	PHASE DIMMING (MANS DIMM)	10000149832	1.696
VL-45-P	6.9 IN	1x10W G16.5/candelabra	120V	Brass/Glossy Opal Glass	WHITE TEXTILE		5741925326	642
VL-45-P	9.8 IN	1x22W A-21/medium	120V	Brass/Glossy Opal Glass	WHITE TEXTILE		5741928530	794
Suspension								
VL45 RADIO 250 SUSPENSION V2 US							5741928556	326
VL45 RADIO 370 SUSPENSION V2 US							5741928543	434

WOHLERT

Pendants

Design: Vilhelm Wohlert

Concept: The fixture provides uniform, general and diffused illumination. The opening at the bottom of the glass produces downwards directed light. The quality of the glass ensures that the fixture is evenly lit.

Finish: White opal glass.

Material: Shade: Hand blown white opal glass. Pendant stem: Brushed steel.

Mounting: Canopy: White. Cord type: 3-conductor, 18 AWG white PVC power cord. Cord length: 12'.

Weight: Max: 9 lbs.

Compliance: cULus, Dry location.

Info notes: Electrical:
 System Wattage: 22W - 44W
 LED Wattage: 20 W - 42 W
 Delivered lumens: 894 - 1,085 lm
 Efficacy: 24.6 - 40.6 lm/W

Certifications:
 cULus, Dry Location
 Protection class IP20
 Controllability: Phase dimming or 0-10V dimming.
 Color Rendering: Ra≥90 for LED variants.
 Performance dependent upon screw-base lamp used in socketed variants.



Product Code	Dimensions	Light source	Voltage	Finish	Cable type	Lighting control	Item number	Price
WOP	11.8 IN	1x22W A-21/medium	120V	White Opal Glass	WHT		10000124355	994
WOP	13.7 IN	1x22W A-21/medium	120V	White Opal Glass	WHT		10000124356	1.114
WOP	13.7 IN	44W LED/3000-1800K D2W	120-277V/60HZ	White Opal Glass	WHITE TEXTILE	DIM 0-10V	10000149848	1.716
WOP	13.7 IN	44W LED/3000-1800K D2W	120V	White Opal Glass	WHITE TEXTILE	PHASE DIMMING (MAINS DIMM)	10000149850	1.716
WOP	13.7 IN	44W LED/3000K	120-277V/60HZ	White Opal Glass	WHITE TEXTILE	DIM 0-10V	10000149844	1.716
WOP	15.7 IN	1x22W A-21/medium	120V	White Opal Glass	WHT		10000124357	1.236
WOP	15.7 IN	44W LED/3000-1800K D2W	120-277V/60HZ	White Opal Glass	WHITE TEXTILE	DIM 0-10V	10000149849	1.838
WOP	15.7 IN	44W LED/3000-1800K D2W	120V	White Opal Glass	WHITE TEXTILE	PHASE DIMMING (MAINS DIMM)	10000149851	1.838
WOP	15.7 IN	44W LED/3000K	120-277V/60HZ	White Opal Glass	WHITE TEXTILE	DIM 0-10V	10000149845	1.838
WOP	15.7 IN	44W LED/3000K	120V	White Opal Glass	WHITE TEXTILE	PHASE DIMMING (MAINS DIMM)	10000149847	1.838

AJ MINI TABLE

Table lamps

Design: Arne Jacobsen

Concept: The fixture emits downward directed light. The angle of the shade can be adjusted to optimize light distribution. The shade is painted white on the inside to ensure a soft comfortable light.

Finish: Stainless Steel, polished. White, Black, Aubergine, Dark Green, Dark Grey, Light Grey, Midnight Blue, Original Grey, Pale Petroleum, Pale Rose, Rusty Red, Ultra Blue, Yellow Ochre, wet painted.

Material: Shade: Spun steel or stainless steel. Base: Die cast zinc or stainless steel. Stem: Steel or stainless steel.

Mounting: Cable type: Plastic cord with plug. Cable length: 7 ft. Light control: Switch on lamp stand.

Compliance: cULus, Dry location.

Info notes: The white version is supplied with a white cable. The other versions are supplied with a black cable.

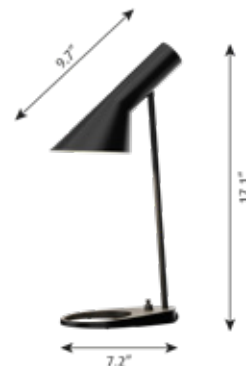

Light source	Finish	Cable type	Item number	Price
1x10W E12	Aubergine	BLK	5744907338	1.028
1x10W E12	Black	BLK	5744907286	1.028
1x10W E12	Dark Green	BLK	5744907354	1.028
1x10W E12	Dark Grey	BLK	5744907341	1.028
1x10W E12	Light Grey	BLK	5744907299	1.028
1x10W E12	Midnight Blue	BLK	5744907325	1.028
1x10W E12	Pale Petroleum	BLK	5744907367	1.028
1x10W E12	Rusty Red	BLK	5744907312	1.028
1x10W E12	White	WHT	5744907273	1.028
1x10W E12	Yellow Ochre	BLK	5744907309	1.028
1x10W G16.5/candelabra	Stainless Steel Polished	BLK	5744915663	1.154

AJ OXFORD TABLE LAMP

Table lamps

Design: Arne Jacobsen

Concept: This table lamp emits a pleasant downwardly directed light, which harmoniously illuminates the surface below it through the soft transparency of its triple-layered hand-blown opal glass. In the variant without the top metal shade, the milky opal-glass shade provides further glow to form an alluring halo around the fixture.

Finish: Black wet-painted stem with shade in triple-layered hand-blown opal glass.
Top shade: Black wet-painted with white interior.

Material: Shade: hand-blown, triple-layered, white-opal glass.
 Stem and top shade: Steel.
 Mounting device for pin mounting: Aluminum.
 Union nut and finger screw in untreated brass with fine clockwise hairlines.

Please note that the untreated brass will patinate.

Mounting: Cable type: Black fabric cord with plug. Cord length: 7 ft.
 Light control: On/off switch on socket house with union nut in untreated brass.
 Pin solution available for 16.1 IN: Cut-out dimension 1.7 IN diameter, table thickness: 0.3 - 1.7 in.

Weight: Max. 4 lbs.

Compliance: Ingress protection IP20.

Info notes: Union nut and finger screw in untreated brass which will patinate.
 Pin solution available for 16.1 IN and 11.0 IN available upon request.

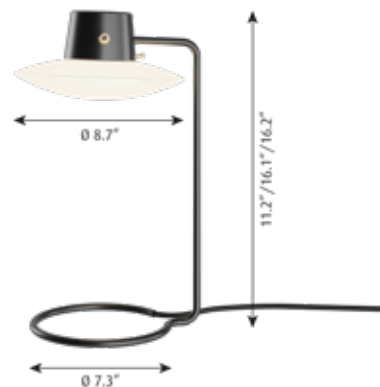

Product Code	Dimensions	Light source	Finish	Shade	Mounting	Item number	Price
AJO-T	280mm	G16.5/candelabra	Metal Black/Opal Glass	W/SHADE	BASE	5744908829	1.018
AJO-T	280mm	G16.5/candelabra	Opal	OPAL GLASS	BASE	5744908777	840
AJO-T	410mm	G16.5/candelabra	Metal Black/Opal Glass	W/SHADE	BASE	5744908722	1.162
AJO-T	410mm	G16.5/candelabra	Opal	OPAL GLASS	BASE	5744908670	982
AJO-T	410mm	G16.5/candelabra	Opal	OPAL GLASS	PIN Ø10	5744908874	982
Sparepart							
AJ EKLIPTA 220 GLASS						5743590005	386

AJ TABLE

Table lamps

Design: Arne Jacobsen

Concept: The fixture emits downward directed light. The angle of the shade can be adjusted to optimize light distribution. The shade is painted white on the inside to ensure a soft comfortable light.

Finish: Dark green, dark grey, aubergine, light grey, midnight blue, pale petroleum, rusty red, yellow ochre, black or white, wet painted.

Material: Base: Die cast zinc. Shade: Spun steel. Stem: Steel.

Mounting: Cord type: White (White finish), black (non-white finish). Cord length: 10'.
Switch: On/off switch on the base.

Weight: Max: 6 lbs.

Compliance: cULus, Dry location.

Info notes: The white version is supplied with a white cable. The other versions are supplied with a black cable.



Product Code	Light source	Voltage	Finish	Cable type	Item number	Price
AJ-T	1x15W A-19/medium	120V	Aubergine	BLK	5744905275	1.278
AJ-T	1x15W A-19/medium	120V	Black	BLK	5744905220	1.278
AJ-T	1x15W A-19/medium	120V	Dark Green	BLK	5744905291	1.278
AJ-T	1x15W A-19/medium	120V	Dark Grey	BLK	5744905288	1.278
AJ-T	1x15W A-19/medium	120V	Light Grey	BLK	5744905233	1.278
AJ-T	1x15W A-19/medium	120V	Midnight Blue	BLK	5744905262	1.278
AJ-T	1x15W A-19/medium	120V	Pale Petroleum	BLK	5744905301	1.278
AJ-T	1x15W A-19/medium	120V	Rusty Red	BLK	5744905259	1.278
AJ-T	1x15W A-19/medium	120V	Stainless Steel Polished	BLK	5744915061	1.440
AJ-T	1x15W A-19/medium	120V	White	WHT	5744905217	1.278
AJ-T	1x15W A-19/medium	120V	Yellow Ochre	BLK	5744905246	1.278

KEGLEN TABLE

Table lamps

Design: Big Ideas

Concept: The table lamp's distinctive conical shade has a built-in curved diffuser. This ensures an attractive and glare-free downwardly directed light. The stem morphs into the diffuser shade, folding inward and creating a beautiful organic geometry. A gentle light is also emitted upward through a discreet uniform opening in the top of the shade to create a perfect ambiance.

Finish: Black or white, matte, wet-painted.

Material: Shade: Spun aluminum. Diffusor: Injection molded PC. Base and pin: machined aluminum.

Mounting: Cord type: White or black. Cord length: 10'. Switch: Button on the base. LED driver: Separate, plugs into power outlet. Optional fixed "pin" mount for Ø2.2" hole in desktop.



Compliance: cULus, Dry location.

Info notes: With programming by the customer, there is a possibility to disable the switch.

An integrated memory function ensures that the lamp will return to its latest adjusted lumen output when power has been removed and restored.

Electrical:

System Wattage: 9W

LED Wattage: 8W

Delivered lumens: 383 - 513

Efficacy: 45 lm/W - 60 lm/W (LED)

Certifications:

cULus, Dry Location

Protection class IP20

Controllability: Continuous dimming by integrated button switch.

Color Rendering: Ra≥90

Dim-to-warm LED CCT: 2700K at 100%; 2000K at max dim

Light source	Finish	Cable type	Mounting	Item number	Price
9W LED/2700-2000K D2W	Black	BLK	PIN Ø40	5744166836	700
9W LED/2700-2000K D2W	Black	BLK	BASE	5744166810	700
9W LED/2700-2000K D2W	White	WHT	BASE	5744166807	700
9W LED/2700-2000K D2W	White	WHT	PIN Ø40	5744166823	700
9W LED/3000K	Black	BLK	PIN Ø40	5744167712	700
9W LED/3000K	Black	BLK	BASE	5744167738	700
9W LED/3000K	White	WHT	PIN Ø40	5744167725	700
9W LED/3000K	White	WHT	BASE	5744167741	700
Sparepart					
Keglen Table diffuser				5744167754	14
ADAPTOR 12V BLK				5744164867	62
ADAPTOR 12V WHT				5744164870	62

NJP MINI

Table lamps

Design: nendo

Concept: The fixture emits a softly diffused, downwardly directed, glare-free light. It fades in at a fixed light level when switched on and fades out when switched off. The timer function can be used to switch it off automatically after either four or eight hours. The fixture provides a broad light distribution for its relatively small size. The shade's white-painted interior helps to comfortably reflect the light. The stepless dimmer allows the light to be adjusted to a suitable level between 15 and 100%. The arm has a stationary angle of 15°, and it can rotate 342° around the base. The head can be tilted and rotated to direct the light.

Finish: White, black, light aluminum gray, rose brown, soft pink, petrol blue, or taupe. Powder-coated.

Material: Base: Steel. Arm and lamp head: Aluminum.

Mounting: Cord type: White (White and soft pink finish), black (other finishes). Cord length: 8'. Switch: High/low/off button on the fixture head. LED driver: Separate, plugs into power outlet. Optional auto shut-off timer function after 4 hours or 8 hours.

Compliance: cULus, Dry location.

Info notes: The arm has a stationary angle of 15°. Head can tilt and rotate. The arm can rotate 342° around the base.

A single push button located at the lamp head controls on/off and dimming. Light turns on/off with light fading in/out. Stepless dimming of the light to a suitable level between 15 and 100%. Timer function to automatically turn off the light after a period of time, selectable between 4 hours or 8 hours. Function to set a fixed brightness level each time the lamp is connected to main power.



Light source	Finish	Cable type	Item number	Price
10W LED/2700K	Black	BLK	5744168122	658
10W LED/2700K	Brown Rose	BLK	5744168151	658
10W LED/2700K	Light Aluminum Grey	BLK	5744168148	658
10W LED/2700K	Petrol Blue	BLK	5744168180	658
10W LED/2700K	Soft Pink	WHT	5744168164	658
10W LED/2700K	Taupe	BLK	5744168177	658
10W LED/2700K	White	WHT	5744168135	658

NJP TABLE

Table lamps

Design: nendo

Concept: The fixture provides direct glare-free horizontal light while reflecting some of the light through the rear of the head, illuminating the top of the arm. The ergonomic design of the fixture head shapes the light and gives optimal light direction. A simple mechanical system provides great freedom of movement, so the light can always be set in the ideal position in the workspace. The shade is painted white on the inside, reflecting comfortable diffused light.

Finish: White, Black or Light Aluminium Grey, powder coated.

Material: Base: Steel. Arms and lamp head: Aluminum. Joints: Anodized aluminum.

Mounting: Cord type: White (White finish), black (non-white finish). Cord length: 6'. Switch: High/low/off button on the fixture head. Timer function: 4 hours or 8 hours. LED driver: Separate, plugs into power outlet.

Weight: Max: 6 lbs.

Compliance: cULus, Dry location.



Product Code	Light source	Voltage	Finish	Mounting	Item number	Price
NJP-T	10W LED/2700K	120V	Black	BASE	10000133058	750
NJP-T	10W LED/2700K	120V	Black	CLAMP	10000133059	676
NJP-T	10W LED/2700K	120V	Black	PIN Ø10	10000133060	658
NJP-T	10W LED/2700K	120V	Light Aluminium Grey	BASE	10000142404	750
NJP-T	10W LED/2700K	120V	Light Aluminium Grey	CLAMP	10000142405	676
NJP-T	10W LED/2700K	120V	Light Aluminium Grey	PIN Ø10	10000142406	658
NJP-T	10W LED/2700K	120V	White	BASE	10000133061	750
NJP-T	10W LED/2700K	120V	White	CLAMP	10000133062	676
NJP-T	10W LED/2700K	120V	White	PIN Ø10	10000133063	658
NJP-T	10W LED/3000K	120V	Black	BASE	10000133064	750
NJP-T	10W LED/3000K	120V	Black	CLAMP	10000133065	676
NJP-T	10W LED/3000K	120V	Black	PIN Ø10	10000133066	658
NJP-T	10W LED/3000K	120V	Light Aluminium Grey	BASE	10000138372	750
NJP-T	10W LED/3000K	120V	Light Aluminium Grey	CLAMP	10000138373	676
NJP-T	10W LED/3000K	120V	Light Aluminium Grey	PIN Ø10	10000138374	658
NJP-T	10W LED/3000K	120V	White	CLAMP	10000133068	676
NJP-T	10W LED/3000K	120V	White	PIN Ø10	10000133069	658
NJP-T	10W LED/3000K	120V	White	BASE	10000133067	750
Sparepart						
	ADAPTOR 12V BLK				5744164867	62
	ADAPTOR 12V WHT				5744164870	62
Accessories						
	NJP TABLE BASE WHT				5744164689	142
	NJP TABLE BASE BLK				5744164692	142
	NJP TABLE PIN Ø10				5744164728	50
	NJP TABLE CLAMP WHT				5744164702	68
	NJP TABLE CLAMP BLK				5744164715	68
	NJP TABLE PIN Ø40				5744165170	86

PANTHELLA MINI

Table lamps

Design: Verner Pantton

Concept: The fixture emits a soft, comfortable, glare-free, light. The metal-shade versions direct the light directly downward, creating a pleasant illumination due to the inner white-painted shade and the reflection from the trumpet-shaped stem. The opal acrylic produces a diffused, comfortable light due to the translucent shade, the downward reflection from the inner shade, and the reflection from the trumpet-shaped stem.

Finish: White Opal Acrylic shade with white stand.
 Gray Opal Acrylic shade with high-luster chrome stand.
 High-Luster Chrome shade and stand.
 Metalized Brass shade and stand.
 White, Black, or Orange shade and stand, Powder-coated.

Material: Shade: Injection-molded acrylic or deep-drawn steel.
 Base and housing: Cast aluminum.

Diffuser: Injection-molded opal pmma.

Mounting: Cable type: White for brass, pale rose and white finishes; Black for other finishes. Cable length: 8'. LED-driver: Separate, plugs into power outlet. Light control: In-line switch. Auto shut-off timer: 4 hours/8 hours. Continuous dimming from 15% to 100%.

Weight: Max: 3 lbs.

Compliance: cULus, Dry location.

Info notes: Electrical:

System Wattage: 10W
 LED Wattage: 9W
 Delivered lumens: 428-589
 Efficacy: 42 - 58 lm/W (LED)

Certifications:
 cULus, Dry Location
 Protection class IP20
Controllability: Continuous dimming by touch switch on cord.
Color Rendering: Ra≥90

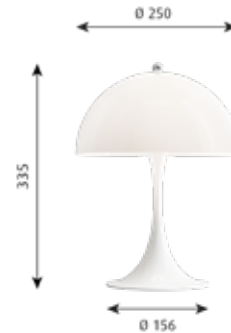

Product Code	Light source	Voltage	Finish	Cable type	Item number	Price
PAN-MINI	10W LED/2700K	120V	Black		5744162432	618
PAN-MINI	10W LED/2700K	120V	Brass Metalized	WHT	5744167110	1.028
PAN-MINI	10W LED/2700K	120V	Coral	BLK	5744612652	618
PAN-MINI	10W LED/2700K		Grey Opal Acrylic	BLK	5744168038	724
PAN-MINI	10W LED/2700K	120V	High Lustre Chrome Plated		5744162555	822
PAN-MINI	10W LED/2700K	120V	Orange		5744162474	618
PAN-MINI	10W LED/2700K	120V	Pale Blue	BLK	5744612649	618
PAN-MINI	10W LED/2700K	120V	Pale Rose	WHT	5744162937	618
PAN-MINI	10W LED/2700K	120V	White		5744162513	618
PAN-MINI	10W LED/2700K	120V	White Opal Acrylic		5744162461	618
Sparepart						
PANTHELLA MINI SHADE PALE ROSE NEW					5744902087	138
PANTHELLA MINI SHADE CORAL					5744612717	144
PANTHELLA MINI SHADE OPAL GREY					5744168054	176
ADAPTOR 12V BLK					5744164867	62
ADAPTOR 12V WHT					5744164870	62
PANTHELLA MINI CORD WHT					5744168436	Contact LP

PANTHELLA PORTABLE

Table lamps

Design: Verner Panton

Concept:

This portable table lamp emits soft, comfortable, glare-free light. The metal-shade variants reflect the light downward, creating a pleasant illumination due to the inner white-painted shade and the reflection from the trumpet-shaped stem. The opal acrylic variants provide gentle illumination and a subtle ambiance due to the shade's transparency and the reflection of the downward light on the inside of the shade.

Finish: White Opal Acrylic shade with white stand.
 Grey Opal Acrylic shade with high lustre chrome stand.
 Pale Rose, Pale Blue or Coral, powder coated.

Material: Shade: Deep-drawn steel or injection-molded opal-gray acrylic or white-opal acrylic.
 Base and housing: Die-cast aluminum.

Mounting: Cable length: 4.9ft. Power: USB cable or Qi base for standard USB-A adapter. Light control: Switch on base. Battery lifetime: 5 hours @ 100%. Step-dim: 0%/10%/33%/100%

Compliance: cULus, Damp location.

Info notes: Please note that Panthella Portable comes with a USB cable but without an adapter and Qi charger. A separate USB adapter is available as an accessory. Compatible with standard USB adapters (Min. 1.5A) and Qi wireless chargers. White cord for White Opal and Pale Rose variants. Black cord for other variants.

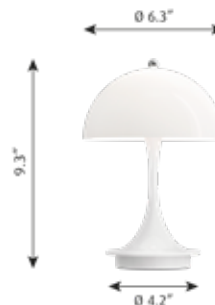

Light source	Finish	Cable type	Item number	Price
3W LED/2700K	Black	BLK	5744612571	412
3W LED/2700K	Coral	BLK	5744612623	394
3W LED/2700K	Grey Opal Acrylic	BLK	5744168070	446
3W LED/2700K	Opal	WHT	5744166768	394
3W LED/2700K	Orange	BLK	5744612584	412
3W LED/2700K	Pale Blue	BLK	5744612610	394
3W LED/2700K	Pale Rose	WHT	5744162924	394
3W LED/2700K	White	WHT	5744612607	412
Sparepart				
PANTHELLA PORTABLE SHADE PALE BLUE			5744612665	Contact LP
PANTHELLA PORTABLE SHADE CORAL			5744612678	Contact LP

PANTHELLA TABLE

Table lamps

Design: Verner Panton

Concept: The fixture emits a soft and comfortable illumination. The hemispherical shade reflects the light downwards, and the material used ensures that the majority of the light is spread diffusely in the room from the surface of the shade.

Finish: White, opal acrylic.

Material: Base: White, injection molded ABS. Shade: Injection molded white opal acrylic. Housing: White, injection molded ABS.

Mounting: Cord type: White. Cord length: 13'. Switch: In-line on/off switch provided.

Weight: Max: 8 lbs.

Compliance: cULus, Dry location.



Product Code	Light source	Voltage	Finish	Item number	Price
PAN-T	A-19/medium	120V	White Opal Acrylic	5744916510	1.010

PANTHELLA TABLE 320

Table lamps

Design: Verner Panton

Concept: The fixture emits a soft, comfortable, glare-free, light. The metal-shade versions direct the light directly downward, creating a pleasant illumination due to the inner white-painted shade and the reflection from the trumpet-shaped stem. The opal acrylic produces a diffused, comfortable light due to the translucent shade, the downward reflection from the inner shade, and the reflection from the trumpet-shaped stem.

Finish: White opal acrylic shade with white stand.
 Gray opal acrylic shade with high-luster chrome stand.
 High-luster chrome shade and stand.
 Brass metallized shade and stand.

Material: Shade: Injection-molded acrylic or deep-drawn steel. Base and housing: Cast aluminum.
 Diffuser: Injection-molded opal pmma.

Mounting: Cable type: White for white and brass finishes; Black for other finishes.
 Cable length: 8'. Switch: In-line on/off. Diffuser with bayonet lock.

Compliance: cULus, Dry location.

Info notes: Electrical:
 System Wattage: 10W
 Delivered lumens: 270 - 367 lm
 Efficacy: 27 - 36 lm/W
 Certifications:
 cULus, Dry Location
 Protection class IP20
 Color Rendering: Ra≥90
 Actual performance dependent upon screw-base lamp used.



Light source	Voltage	Finish	Cable type	Item number	Price
1x10W G16.5/candelabra	120V	Brass Metallized	WHT	5744918107	1.232
1x10W G16.5/candelabra	120V	High Lustre Chrome Plated	BLK	5744918055	1.028
1x10W G16.5/candelabra	120V	White Opal Acrylic	WHT	5744918000	768
1x7.5W G16.5/candelabra		Grey Opal Acrylic	BLK	5744908405	912
Sparepart					
PANTHELLA TABLE 320 SHADE OPAL GREY				5744168041	244

PH 2/1 TABLE

Table lamps

Design: Poul Henningsen

Concept: The fixture provides soft lighting. PH 2/1 is designed on the principle of a reflecting multi-shade system, creating harmonious and glare-free lighting. The shade design is based on a logarithmic spiral, with the center of the light source placed in the spiral's focal point.

Finish: Brass metallized, black metallized or high lustre chrome plated. White opal glass.

Material: Shades: Hand-blown white opal glass. Top plate: Brass metallized, black metallized or high lustre chrome plated, machined brass. Base and stem: Brass metallized, black metallized or high lustre chrome plated, brass.

Mounting: Cord type: Black for black and chrome colors; white for brass. Cord length: 10'. Switch: On/off switch on cord.

Weight: Max. 4 lbs.

Compliance: cULus, Dry location.



Light source	Voltage	Finish	Cable type	Item number	Price
1x4W T-4 G9	120V	Black Metallized	BLK	5744907121	1.144
1x4W T-4 G9	120V	Brass Metallized	WHT	5744907105	1.144
1x4W T-4 G9	120V	High Lustre Chrome Plated	BLK	5744907118	1.024

PH 3/2 GLASS TABLE

Table lamps

Design: Poul Henningsen

Concept: The fixture is designed based on the principle of a reflective three-shade system, which directs the majority of the light downwards. The shades are made of hand blown opal three-layer glass, which is glossy on top and sandblasted matte on the underside, giving a soft and diffused light distribution.

Finish: Black metalized or high lustre chrome plated. White opal glass.

Material: Base: Black metalized or high lustre chrome plated, brass. Shades: Hand blown white opal glass. Top plate: Black metalized or high lustre chrome plated, spun brass. Stem: Black metalized or high lustre chrome plated, brass.

Mounting: Cord type: Black. Cord length: 10'. Switch: In-line on/off switch provided.

Weight: Max: 7 lbs.

Compliance: cULus, Dry location.



Product Code	Light source	Voltage	Finish	Cable type	Item number	Price
PH3/2-T	1x10W G16.5/candelabra	120V	Black Metalized	BLK	5744901512	1.618
PH3/2-T	1x10W G16.5/candelabra	120V	Brass Metalized	WHT	5744901826	1.618
PH3/2-T	1x10W G16.5/candelabra	120V	High Lustre Chrome Plated	BLK	5744901350	1.474

PH 3¹/₂-2¹/₂ GLASS TABLE

Table lamps

Design: Poul Henningsen

Concept: The fixture is designed based on the principle of a reflective three-shade system, which directs the majority of the light downwards. The shades are made of hand blown opal three-layer glass, which is glossy on top and sandblasted matte on the underside, giving a soft and diffused light distribution.

Finish: Black metalized or high lustre chrome plated. White opal glass.

Material: Shades: Hand blown white opal glass. Top plate: Black metalized or high lustre chrome plated, spun brass. Base and stem: Black metalized or high lustre chrome plated, brass.

Mounting: Cord type: Black. Cord length: 12'. Switch: In-line on/off switch provided.

Weight: Max: 15 lbs.

Compliance: cULus, Dry location.



Product Code	Light source	Voltage	Finish	Cable type	Item number	Price
PH3 ¹ / ₂ -2 ¹ / ₂ -T-G	1x10W G16.5/candelabra	120V	Black Metalized	BLK	5744903853	1.894
PH3 ¹ / ₂ -2 ¹ / ₂ -T-G	1x10W G16.5/candelabra	120V	Brass Metalized	WHT	5744901868	1.894
PH3 ¹ / ₂ -2 ¹ / ₂ -T-G	1x10W G16.5/candelabra	120V	High Lustre Chrome Plated	BLK	5744903837	1.750

PH 3½-2½ TABLE

Table lamps

Design: Poul Henningsen

Concept: The louvre is 100% glare-free, with a design based on the principle of a reflective three-shade system, which directs most of the light downwards. For some variants, the top shade is made of deep drawn aluminum with white inner surface that ensures gentle, downward light distribution. The two bottom handblown opal glass shades ensure a large glare-free light surface, making optimum use of the light source to provide comfortable, functional lighting.

Finish: Red, green, yellow and white, powder coated. Base: silk matte brown, copper.

Material: Shades: deep drawn aluminum. Base: silk matte brown, copper.

Mounting: Cord type: Black. Cord length: 12'. Switch: In-line on/off switch provided.

Weight: Max: 8 lbs.

Compliance: cULus, Dry location.



Product Code	Light source	Voltage	Finish	Item number	Price
PH3½2½-T	1x10W G16.5/IF candelabra US	120V	Green	5744902731	1.708
PH3½2½-T	1x10W G16.5/IF candelabra US	120V	Red	5744902702	1.708
PH3½2½-T	1x10W G16.5/IF candelabra US	120V	White	5744902715	1.708
PH3½2½-T	1x10W G16.5/IF candelabra US	120V	Yellow	5744902728	1.708

PH 4/3 TABLE

Table lamps

Design: Poul Henningsen

Concept: The fixture is designed based on the principle of a reflective three-shade system, which directs the majority of the light downwards. The shades are made of metal and painted white to ensure a diffused, comfortable light distribution.

Finish: White, powder coated. High lustre chrome plated.

Material: Base: High lustre chrome plated, spun brass. Shades: Spun aluminum. Stem: High lustre chrome plated, steel. Triangular piece: Black, injection molded bakelite.

Mounting: Cord type: Black. Cord length: 8'. Switch: In-line on/off switch provided.

Weight: Max: 7 lbs.

Compliance: cULus, Dry location.



Product Code	Light source	Voltage	Finish	Mounting	Item number	Price
PH4/3-T	1x15W A-19/medium	120V	White	FREE STANDING	5744904522	1.314
Sparepart						
PH 4-3 TABLE, LAMPHOLDER ASS.					5744610696	146
PH 4-3 TABLE MIDDLE/LOWER SHADESET NEW					5744610829	228
PH 4-3 TABLE, LAMPHOLDER BRACKET					5744610706	Contact LP

PH 4¹/₂-3¹/₂ GLASS TABLE

Table lamps

Design: Poul Henningsen

Concept: The fixture is designed based on the principle of a reflective three-shade system, which directs the majority of the light downwards. The shades are made of hand blown opal three-layer glass, which is glossy on top and sandblasted matte on the underside, giving a soft and diffused light distribution.

Finish: High lustre chrome plated. White opal glass.

Material: Base: High lustre chrome plated, spun brass. Shades: Hand blown white opal glass. Anti-glare ring: Purple, spun aluminum. Top plate: High lustre chrome plated, spun brass. Stem: High lustre chrome plated, steel.

Mounting: Cord type: Black. Cord length: 9'. Switch: On/off switch on the base.

Weight: Max: 22 lbs.

Compliance: cULus, Dry location.



Product Code	Light source	Voltage	Finish	Item number	Price
PH4 ¹ / ₂ -3 ¹ / ₂ -T	1x15W A-19/IF medium	120V	High Lustre Chrome Plated	5844901253	4.300

VL38 TABLE

Table lamps

Design: Vilhelm Lauritzen

Concept: The fixture emits downward directed light. The angle of the shade can be adjusted to optimize light distribution. The shade is painted white on the inside to ensure a soft comfortable light.

Finish: Brushed brass. Black or white, powder coated.

Material: Base: Die cast aluminum Shade: Spun aluminum. Stem: Brushed brass.

Mounting: Cord type: White or black. Cord length: 10'. Switch: High/low/off switch on the base. LED driver: Separate, plugs into power outlet.

Weight: Max: 5 lbs.

Compliance: cULus, Dry location.

Info notes: Please note that the brass surfaces are untreated. This means that the surface will change over time and develop a patina.



Product Code	Light source	Voltage	Finish	Item number	Price
VL38-T	10W LED/2700K	120V	Black	5744163211	768
VL38-T	10W LED/2700K	120V	White	5744162322	768
Sparepart					
VL38 REPLACEMENT KIT LED W/WIRE				5744165963	26
ADAPTOR 12V BLK				5744164867	62
ADAPTOR 12V WHT				5744164870	62

YUH TABLE

Table lamps

Design: GamFratesi

Concept: The fixture primarily provides glare-free downward directed light. The angle of the shade can be adjusted to optimize light distribution. A slim opening in the top of the shade provides soft, ambient upward illumination. A mechanical system provides great freedom of movement, so the light can always be set in the ideal position in the workspace, living room etc. Built-in LED technology provides a high quality of light with stepless dimming from 100% to 15%. Optional timer capability automatically turns off the light after a chosen duration of 4 or 8 hours. Returns to the last dim level setting when switched on. A button at the top of the tube acts as switch and dimmer.

Finish: White or black: Matte wet painted.

Brass/Marble versions: White or black shade matte wet painted. . Brushed brass stem, clear lacquered. Matte marble base.

Material: Shade: Die cast aluminum. Base: Die cast aluminum (wet painted) or brushed marble. Marble: Italian Nero Margiua or White Carrara. Stem: Extruded brass (wet painted or clear lacquered).

Mounting: Cord type: White or black. Cord length: 10'. Switch: High/low/off switch on the base. LED driver: Separate, plugs into power outlet.

Weight: Max: 5 lbs.

Compliance: cULus, Dry location.

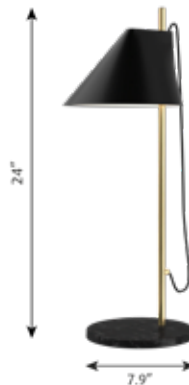

Product Code	Light source	Voltage	Finish	Mounting	Item number	Price
YUH-T	10W LED/2700K	120V	Black	BLACK BASE	5744612555	886
YUH-T	10W LED/2700K	120V	Brass/Black	BLACK MARBLE BASE	5744162652	1.036
YUH-T	10W LED/2700K	120V	Brass/White	WHITE MARBLE BASE	5744162665	1.036
YUH-T	10W LED/2700K	120V	White	WHITE BASE	5744612568	886
Sparepart						
ADAPTOR 12V BLK					5744164867	62
ADAPTOR 12V WHT					5744164870	62

AJ EKLIPTA WALL

Wall lamps

Design: Arne Jacobsen

Concept: The fixture emits soft comfortable light. The glass is designed to provide a uniformly lit surface. The three-layer hand blown opal glass shade has a transparent edge, providing a decorative halo of light around the fixture.

Finish: White, powder coated. White opal glass.

Material: Ceiling/Wall box: Spun aluminum. Diffuser: Hand blown white opal glass.

Mounting: Surface: Mounted directly to finished surface over a recessed 4" octagonal junction box (13.7"/17.7") or 3" octagonal junction box (8.7").

Weight: Max: 11 lbs.

Compliance: cULus, Wet location.

Info notes: Electrical:

LED System Wattage: 10W or 24W

LED Wattage: 9W or 22W

Delivered lumens: 371 - 1,937

Efficacy: 37.1 lm/W - 80.7 lm/W

Certifications: cULus, Wet Location (Incandescent variants), Damp location (LED variants)

Protection class IP20

Controllability: 0-10V Dimming, Phase Dimming

Color Rendering: Ra≥90

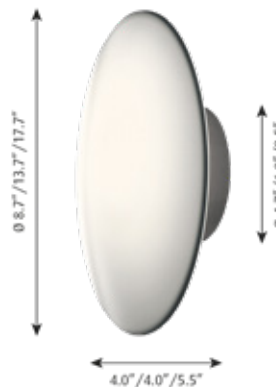

Product Code	Dimensions	Light source	Voltage	Finish	Shield/Diffuser	Body	Mounting	Lighting control	Item number	Price
AJE	13.7 IN	10W LED/3000K	120-277V/60HZ	White			WALL AND SURFACE	DIM 0-10V	10000121108	1.378
AJE	13.7 IN	1x60W A-19/IF medium	120V	White			WALL AND SURFACE		5842905400	778
AJE	17.7 IN	1x100W A-19/IF medium	120V	White			WALL AND SURFACE		5842905426	1.038
AJE	17.7 IN	25W LED/3000K	120-277V/60HZ	White			WALL AND SURFACE	DIM 0-10V	10000121113	1.780
AJE	8.7 IN	10W LED/3000K		White	WHITE OPAL	BOX WO/SIDE CABLE HOLES	WALL AND CEILING		5743911192	756
AJE	8.7 IN	1x40W 30W G9	120V	White	WHITE OPAL		WALL AND CEILING		5743908011	664
Sparepart										
AJ EKLIPTA 220 GLASS									5743590005	386

AJ WALL

Wall lamps

Design: Arne Jacobsen

Concept: The fixture emits downward directed light. The angle of the shade and rotation can be adjusted to optimize light distribution. The shade is painted white on the inside to ensure a soft comfortable light.

Finish: Dark green, dark grey, aubergine, light grey, midnight blue, pale petroleum, rusty red, yellow ochre, black or white, wet painted.

Material: Shade: Spun steel or stainless steel. Wall box: Spun steel or deep drawn stainless steel. Arm: Steel or stainless steel.

Mounting: Mounted directly to finished surface over a 4" octagonal junction-box. On/off switch on the wall plate, white for white finish, black for non-white finishes. Variants without on/off switch to be remotely controlled.

Weight: Max: 6 lbs.

Compliance: cULus, Dry location.

Info notes: Electrical:

Wattage: 10W

Delivered lumens: 263

Efficacy: 26.3 lm/W

Certifications:

cULus, Dry Location

Protection class IP20

Controllability: Phase Dimming

Color Rendering: Ra≥90

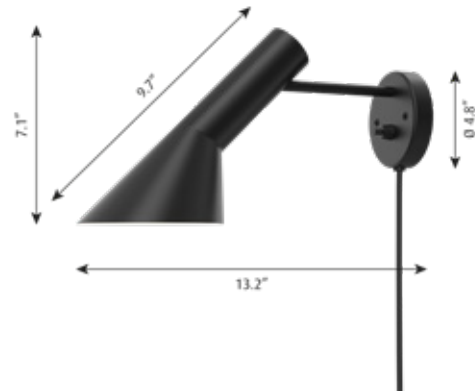

Product Code	Light source	Voltage	Finish	Shade	Switch/Plug	Cable type	Item number	Price
AJ-W	1x10W G16.5/candelabra	120V	Aubergine	TILTABLE	WITH SWITCH	W/O Cord	5743907339	982
AJ-W	1x10W G16.5/candelabra	120V	Aubergine	TILTABLE	WITHOUT SWITCH	W/O Cord	5743915156	982
AJ-W	1x10W G16.5/candelabra	120V	Black	TILTABLE	WITHOUT SWITCH	W/O Cord	5743915101	982
AJ-W	1x10W G16.5/candelabra	120V	Black	TILTABLE	WITH SWITCH	W/O Cord	5743907287	982
AJ-W	1x10W G16.5/candelabra	120V	Dark Green	TILTABLE	WITH SWITCH	W/O Cord	5743907355	982
AJ-W	1x10W G16.5/candelabra	120V	Dark Green	TILTABLE	WITHOUT SWITCH	W/O Cord	5743915172	982
AJ-W	1x10W G16.5/candelabra	120V	Dark Grey	TILTABLE	WITH SWITCH	W/O Cord	5743907342	982
AJ-W	1x10W G16.5/candelabra	120V	Dark Grey	TILTABLE	WITHOUT SWITCH	W/O Cord	5743915169	982
AJ-W	1x10W G16.5/candelabra	120V	Light Grey	TILTABLE	WITH SWITCH	W/O Cord	5743907290	982
AJ-W	1x10W G16.5/candelabra	120V	Light Grey	TILTABLE	WITHOUT SWITCH	W/O Cord	5743915114	982
AJ-W	1x10W G16.5/candelabra	120V	Midnight Blue	TILTABLE	WITH SWITCH	W/O Cord	5743907326	982
AJ-W	1x10W G16.5/candelabra	120V	Midnight Blue	TILTABLE	WITHOUT SWITCH	W/O Cord	5743915143	982
AJ-W	1x10W G16.5/candelabra	120V	Pale Petroleum	TILTABLE	WITH SWITCH	W/O Cord	5743907368	982
AJ-W	1x10W G16.5/candelabra	120V	Pale Petroleum	TILTABLE	WITHOUT SWITCH	W/O Cord	5743915185	982
AJ-W	1x10W G16.5/candelabra	120V	Rusty Red	TILTABLE	WITH SWITCH	W/O Cord	5743907313	982
AJ-W	1x10W G16.5/candelabra	120V	Rusty Red	TILTABLE	WITHOUT SWITCH	W/O Cord	5743915130	982
AJ-W	1x10W G16.5/candelabra	120V	Stainless Steel Polished		BLK SWITCH	W/O Cord	5743914348	1.046
AJ-W	1x10W G16.5/candelabra	120V	White	TILTABLE	WITH SWITCH	W/O Cord	5743907274	982
AJ-W	1x10W G16.5/candelabra	120V	White	TILTABLE	WITHOUT SWITCH	W/O Cord	5743915091	982
AJ-W	1x10W G16.5/candelabra	120V	Yellow Ochre	TILTABLE	WITH SWITCH	W/O Cord	5743907300	982
AJ-W	1x10W G16.5/candelabra	120V	Yellow Ochre	TILTABLE	WITHOUT SWITCH	W/O Cord	5743915127	982

KEGLEN WALL

Wall lamps

Design: Big Ideas

Concept: The wall lamp's distinctive conical shade has a built-in curved diffuser. This ensures an attractive and glare-free light. A gentle light is also emitted upward through a discreet uniform opening in the top of the shade to create a perfect ambiance. The fixture can be mounted facing downward to direct the light to a specific spot, or upward for indirect light.

Finish: Black or white, matte, wet-painted.

Material: Shade: Spun aluminum. Diffusor: Injection molded PC.

Mounting: Mounted directly to finished surface over a 4" octagonal junction-box.
Switch: push button switch on the top wall box. Electronic LED driver is housed inside the wall box.

Compliance: cULus, Dry location.

Info notes: Multi-function button switch: tap for switching on/off; press and hold for continuous dimming. May be disabled for on/off operation by remote wall light switch. An integrated memory function ensures that the lamp will return to its last dim level when turned on.

Head can rotate +/- 45° sideways.

Electrical:

System Wattage: 9W

LED Wattage: 8W

Delivered lumens: 338 - 484

Efficacy: 40 lm/W - 57 lm/W (LED)

Certifications:

cULus, Dry Location

Protection class IP20

Controllability: Continuous dimming by integrated button switch.

Color Rendering: Ra≥90

Dim-to-warm LED CCT: 2700K at 100%; 2000K at max dim

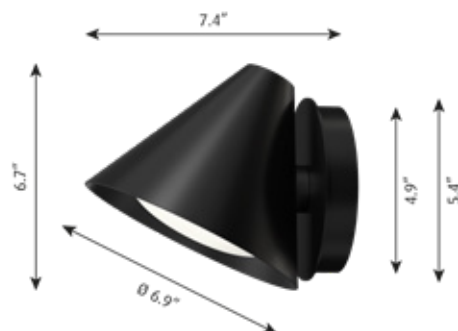

Light source	Finish	Cable type	Item number	Price
9W LED/2700-2000K D2W	Black	BLK	5743914377	744
9W LED/2700-2000K D2W	White	WHT	5743914364	744
9W LED/3000K	Black	BLK	5743916207	744
9W LED/3000K	White	WHT	5743916252	744
Sparepart				
KEGLEN 175 WALL DIFFUSER			5743151787	14

NJP WALL

Wall lamps

Design: nendo

Concept: The fixture provides direct glare-free horizontal light while reflecting some of the light through the rear of the head, illuminating the top of the arm. The ergonomic design of the fixture head shapes the light and gives optimal light direction. A simple mechanical system provides great freedom of movement, so the light can always be set in the ideal position in the workspace. The shade is painted white on the inside, reflecting comfortable diffused light.

Finish: White, Black or Light Aluminium Grey, powder coated.

Material: Arms and lamp head: Aluminum. Joints: Anodized Aluminum. Wall bracket: Aluminum.

Mounting: Cord type: White (White finish), black (non-white finish). Cord length: 6'.
Switch: High/low/off button on the fixture head. Timer function: 4 hours or 8 hours.
LED driver: Separate, plugs into power outlet.

Weight: Max: 6 lbs.

Compliance: cULus, Dry location.

Info notes: Electrical:
 System Wattage: 10W
 LED Wattage: 9W
 Delivered lumens: 550
 Efficacy: 55 lm/W

Certifications:
 cULus, Dry Location
 Protection class IP20
 Controllability: Step dimming
 Color Rendering: Ra≥90



Product Code	Light source	Voltage	Finish	Mounting	Item number	Price
NJP-W	10W LED/2700K	120V	Black	LONG ARM	10000135259	676
NJP-W	10W LED/2700K	120V	Black	SHORT ARM	5743163186	446
NJP-W	10W LED/2700K	120V	Light Aluminum Grey	LONG ARM	10000142408	676
NJP-W	10W LED/2700K	120V	Light Aluminum Grey	SHORT ARM	5743163995	446
NJP-W	10W LED/2700K	120V	White	LONG ARM	10000135261	676
NJP-W	10W LED/2700K	120V	White	SHORT ARM	5743163199	446
NJP-W	10W LED/3000K	120V	Black	LONG ARM	10000135262	676
NJP-W	10W LED/3000K	120V	Black	SHORT ARM	5743163209	446
NJP-W	10W LED/3000K	120V	Dark Aluminum Grey	LONG ARM	10000138379	676
NJP-W	10W LED/3000K	120V	Light Aluminum Grey	LONG ARM	10000138378	676
NJP-W	10W LED/3000K	120V	Light Aluminum Grey	SHORT ARM	5743163348	446
NJP-W	10W LED/3000K	120V	White	SHORT ARM	5743163212	446
NJP-W	10W LED/3000K	120V	White	LONG ARM	10000135263	676
Sparepart						
ADAPTOR 12V BLK					5744164867	62
ADAPTOR 12V WHT					5744164870	62

NJP WALL BOX

Wall lamps

Design: nendo

Concept: The fixture provides direct, glare-free, horizontal light while reflecting some of the light through the rear of the head, illuminating the top of the arm. The ergonomic design of the fixture's head shapes the light for optimal light direction. A simple mechanical system provides great freedom of movement, so the light can always be set in the ideal position. The shade is painted white on the inside, reflecting comfortable and diffused light.

Finish: White, Black or Light Aluminium Grey, powder coated.

Material: Arms and lamp head: Aluminum.

Joints: Anodized Aluminum.

Wall box: Aluminum.

Mounting: Switch: On the fixture head. Stepless dim between 15 and 100%.

Timer function: 4 hours/8 hours.

LED Driver: integrated in the wall-box.

Mounting with cord and plug or for hardwiring.

With cord and plug: Black or white plastic cord.

Cord length: 3.3m (short arm), 2.3m (Long arm).

Without cord for hardwiring: Wall bracket for mounting on wall.



Compliance: cULus, Dry location.

Info notes: Turn on/off with light fading in/out. Stepless dim of the light to a suitable level between 15 and 100%. Timer function to automatically turn off the light after amount of time, selectable between off/4 hours/8 hours. Function to set a fixed light level each time the lamp is connected to main power.

Light source	Finish	Cable type	Mounting	Item number	Price
10W LED/2700K	Black	W/O Cord	LONG ARM	5743916715	768
10W LED/2700K	Black	W/O Cord	SHORT ARM	5743916799	536
10W LED/2700K	Light Aluminum Grey	W/O Cord	SHORT ARM	5743916812	536
10W LED/2700K	Light Aluminum Grey	W/O Cord	LONG ARM	5743916731	768
10W LED/2700K	White	W/O Cord	LONG ARM	5743916728	768
10W LED/2700K	White	W/O Cord	SHORT ARM	5743916809	536
10W LED/3000K	Black	W/O Cord	LONG ARM	5743916676	768
10W LED/3000K	Black	W/O Cord	SHORT ARM	5743916757	536
10W LED/3000K	Light Aluminum Grey	W/O Cord	LONG ARM	5743916692	768
10W LED/3000K	Light Aluminum Grey	W/O Cord	SHORT ARM	5743916773	536
10W LED/3000K	White	W/O Cord	LONG ARM	5743916689	768
10W LED/3000K	White	W/O Cord	SHORT ARM	5743916760	536

PH 2-1 WALL

Wall lamps

Design: Poul Henningsen

Concept: The fixture is designed based on the principle of a reflective three-shade system, which directs the majority of the light downwards. The shades are made of mouth-blown opal three-layer glass, which is shiny on the top and sandblasted matte on the inside, giving a soft and diffuse light distribution.

Finish: White opal glass. High lustre chrome plated.

Material: Shades: Handblown white opal glass. Wall box: High lustre chrome plated, spun brass. Suspension: High lustre chrome plated, spun aluminum. Arm: High lustre chrome plated, brass.

Mounting: Surface: Mounted directly to finished surface over a 4" octagonal junction-box. Switch: On/off switch on the wall plate.

Compliance: cULus, Dry location.

Info notes: Electrical: System Wattage: 10W LED Wattage: 9 W Delivered lumens: 332 Efficacy: 33 lm/W Certifications: cULus, Dry Location Protection class IP20 Controllability: Phase dimming Actual performance dependent upon screw-base lamp used.

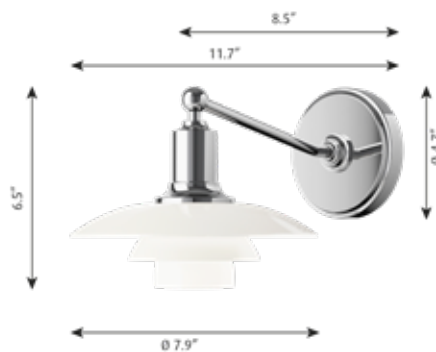

Light source	Finish	Switch/Plug	Cable type	Item number	Price
1x10W E12	White Opal Glass	WITH SWITCH	W/O Cord	5743912696	1.108

PH 3-2 WALL

Wall lamps

Design: Poul Henningsen

Concept: The fixture is designed based on the principle of a reflective three-shade system, which directs the majority of the light downwards. The shades are made of mouth-blown opal three-layer glass, which is shiny on the top and sandblasted matte on the inside, giving a soft and diffuse light distribution.

Finish: White opal glass. High lustre chrome plated.

Material: Shades: Handblown white opal glass. Wall box: High lustre chrome plated, spun brass. Suspension: High lustre chrome plated, spun aluminum. Arm: High lustre chrome plated, brass.

Mounting: Surface: Mounted directly to finished surface over a 4" octagonal junction-box. Switch: On/off switch on the wall plate.

Compliance: cULus, Dry location.

Info notes: Electrical: System Wattage: 10W LED Wattage: 9 W Delivered lumens: 292 Efficacy: 29.2 lm/W Certifications: cULus, Dry Location Protection class IP20 Controllability: Phase dimming Actual performance dependent upon screw-base lamp used.



Light source	Finish	Switch/Plug	Cable type	Item number	Price
1x10W E12	White Opal Glass	WITH SWITCH	W/O Cord	5743909230	1.484

PH HAT

Wall lamps

Design: Poul Henningsen

Concept: The fixture emits indirect 100% glare-free light. The light distribution depends on the angle of the shade. The shade is rose colored on the inside, giving the light a warm tone.

Finish: The outer shade is white, wet-painted. The inner shade is rose-colored, wet-painted.

Material: Shade: Spun steel. Wall box: Spun steel.

Mounting: Surface: Mounted directly to a 4" octagonal junction-box.

Compliance: cULus, Dry location.

Info notes: Electrical:

System Wattage: 10W

Delivered lumens: 174 lm

Efficacy: 17.4 lm/W

Certifications:

cULus, Dry Location

Protection class IP20

Controllability: Phase Dimming

Color Rendering: Ra≥90

Actual performance dependent upon screw-base lamp used.

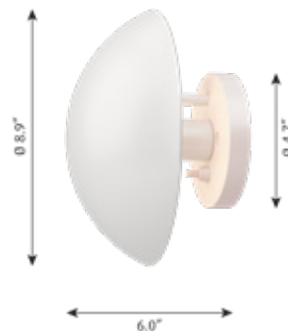

Dimensions	Light source	Finish	Switch/Plug	Cable type	Item number	Price
8.9 IN	1x10W E12	White	WITH SWITCH	W/O Cord	5743914940	554

RIPLS

Wall lamps

Design: Jakob Wagner

Concept: The fixture emits diffused light. The front consist of a concave clear front with ripples - like rings in water. The ripples refract light in the front creating a subtle change of appearance depending on viewing angle. The concave form outlines the refracting light creating a higher intensity light towards the center fading off toward the edges. A diffuser offset sits deep in the fixture creating a sense of depth in the front. A slim housing creates the appearance of a floating disk while perforations in the opaque housing allows indirect light to create a halo around the fixture.

Finish: White opal diffuser and clear reflective front. Satin matte white.

Material: Rear housing: Injection molded polycarbonate. Diffuser: Opalescent PMMA. Clear front: Clear UV resistant polycarbonate.

Mounting: Surface: mounted directly to finished surface over a recessed 4" octagonal junction box.

Weight: Max: 8 lbs.

Compliance: cULus, Damp location.

Info notes: Electrical:
 System Wattage: 13W or 25W
 LED Wattage: 12W or 23W
 Delivered lumens: 1,060 - 2,357
 Efficacy: 81.5 lm/W - 94.3 lm/W
 Certifications:
 cULus, Damp Location
 Protection class IP20
 Controllability: 0-10V Dimming
 Color Rendering: Ra≥90



Product Code	Dimensions	Light source	Voltage	Finish	Lighting control	Item number	Price
RIPLS-CW	12.2 IN	13W LED/3000K	120-277V/60HZ	Opal	DIM 0-10V	10000140832	682
RIPLS-CW	12.2 IN	13W LED/3500K	120-277V/60HZ	Opal	DIM 0-10V	10000140833	682
RIPLS-CW	19.7 IN	25W LED/3000K	120-277V/60HZ	Opal	DIM 0-10V	10000140834	998
RIPLS-CW	19.7 IN	25W LED/3500K	120-277V/60HZ	Opal	DIM 0-10V	10000140835	998

VL RING CROWN WALL

Wall lamps

Design: Vilhelm Lauritzen

Concept: The wall lamp emits light directed primarily downwards. The opal glass provides a comfortable and uniform illumination of the area around the fixture.

Finish: Glossy, hand blown white opal glass. Satin polished brass, untreated.

Material: Hand blown, 3-layered, opal glass. Wall lamp arm and wall-box: Untreated brass, will patinate.

Mounting: Mounting with cord and plug or for hardwiring.
 With cord: White 2 x 0,75 mm² PVC cord with plug. Cord length: 2.5m. Light control: On/off switch on wall box.
 Without cord for hardwiring: Wall bracket for mounting on wall. Light control: Two options. Either with on/off switch on wall box or without switch on wall box with turn on/off at main switch

Compliance: Ingress protection IP20.
 With cord and plug: Electric shock protection II.
 For hardwiring: Electric shock protection I.

Info notes: Please note that the brass surfaces are untreated. This means that the surface will change over time and develop a patina. The total weight of the fixtures are calculated with the average weight of the glass (1.5 lbs.). They vary from 1.3 to 1.8 lbs.



Dimensions	Light source	Voltage	Finish	Switch/Plug	Cable type	Item number	Price	
1	1x40W A-19/medium	120V	Brass/Glossy Opal Glass		W/CORD	5743913611	994	
1	A-19/medium		Brass/Glossy Opal Glass	WITHOUT SWITCH	W/O Cord	5743917510	1.050	
2	2x40W A-19/medium	120V	Brass/Glossy Opal Glass		W/CORD	5743913637	1.524	
2	A-19/medium		Brass/Glossy Opal Glass	WITHOUT SWITCH	W/O Cord	5743917565	1.598	
Sparepart								
VL RING CROWN WALL/3-5-7 GLASS						5741094406	494	

VL STUDIO WALL

Wall lamps

Design: Vilhelm Lauritzen

Concept: The fixture emits a glare-free, diffused light. The triple-layered opal glass provides pleasant and uniform illumination of the area around the fixture. The lampshade can be tilted 90 degrees to the right or left, which allows for flexible light distribution.

Finish: matte black, wet painted or brushed brass with fine hairlines. White opal glass, glossy. Clear lacquered brass.

Material: Glass: Hand-blown, triple-layered opal, glossy.

Housing: Deep-drawn aluminum or brass.

Wall box: Die-cast aluminum or forged brass. Please note that the untreated brass will patinate.

Mounting: Surface: Mounted directly to finished surface over a 4" octagonal junction-box. Glass can be unscrewed to change the light source. No switch is on the luminaire; remote switch is required.

Weight: Max. 1,3 kg.

Compliance: cULus, Dry location.

Info notes: The adjustable lampshade can be tilted 90 degrees to the right or left. The untreated brass will change over time and develop a patina.

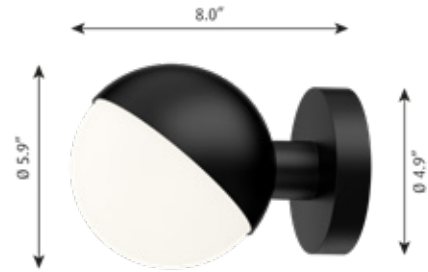

Dimensions	Light source	Voltage	Finish	Cable type	Item number	Price
5.9 IN	1x5W 30W G9	120V	Black	W/O Cord	5743914652	564
5.9 IN	1x5W 30W G9	120V	Lacquered Brass	W/O Cord	5743914704	750
Sparepart						
VL STUDIO 150 TABLE/WALL GLASS					5743151868	158
VL STUDIO 150 WALL PINOL SCREW BLACK					5743151871	6
VL STUDIO TABLE/WALL GROMMET WHITE					5744167877	6
VL STUDIO TABLE/WALL GROMMET BLACK					5744167880	6

VL38 WALL

Wall lamps

Design: Vilhelm Lauritzen

Concept: The fixture emits downward directed light. The angle of the shade can be adjusted to optimize light distribution. The shade is painted white on the inside to ensure a soft comfortable light.

Finish: Brushed brass. Black or White, powder coated.

Material: Wall box: Punched aluminum. Shade: Spun aluminum. Arm: Brushed brass.

Mounting: Surface: Mounted directly to finished surface over a 4" octagonal junction-box.

Weight: Max: 2 lbs.

Compliance: cULus, Dry location.

Info notes: Electrical:
 System Wattage: 10W
 LED Wattage: 9W
 Delivered lumens: 416
 Efficacy: 41.3 lm/W

Certifications:
 cULus, Dry Location
 Protection class IP20
Controllability: Dimming by integral button switch
Color Rendering: Ra≥90

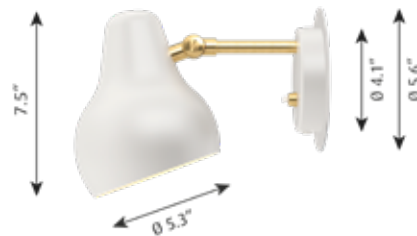

Product Code	Light source	Voltage	Finish	Shade	Item number	Price
VL38-W	10W LED/2700K	120V	Black	TILTABLE	5743903964	546
VL38-W	10W LED/2700K	120V	White	TILTABLE	5743904730	546
Sparepart						
VL38 REPLACEMENT KIT LED W/WIRE					5744165963	26

YUH WALL

Wall lamps

Design: GamFratesi

Concept: The fixture primarily provides glare-free downward directed light. The angle of the shade can be adjusted to optimize light distribution. A slim opening in the top of the shade provides soft, ambient upward illumination. A mechanical system provides great freedom of movement, so the light can always be set in the ideal position in the workspace, living room etc. Built-in LED technology provides a high quality of light with stepless dimming from 100% to 15%. Optional timer capability automatically turns off the light after a chosen duration of 4 or 8 hours. Returns to the last dim level setting when switched on. The switch and dimmer button is placed on the wall box.

Finish: White or black. Matte wet painted. Brass versions: White or black shade. Matte wet painted. Clear lacquered, brushed brass stem and wall box.

Material: Shade: Die cast aluminum. Stem: Extruded brass (wet painted or clear lacquered). Wall box: Die cast aluminum (wet painted) or extruded brass (clear lacquered).

Mounting: Shade: Spun steel. Base: Spun aluminum. Arm: Steel.

Weight: Max: 3 lbs.

Compliance: cULus, Dry location.

Info notes: Electrical:
 System Wattage: 10W
 LED Wattage: 9W
 Delivered lumens: 446
 Efficacy: 44.6 lm/W

Certifications:
 cULus, Dry Location
 Protection class IP20
 Controllability: Dimming by integral button switch
 Color Rendering: Ra≥90



Product Code	Light source	Voltage	Finish	Item number	Price
YUH-W	10W LED/2700K	120V	Black	5743905315	750
YUH-W	10W LED/2700K	120V	Brass/Black	5743913789	850
YUH-W	10W LED/2700K	120V	Brass/White	5743913792	850
YUH-W	10W LED/2700K	120V	White	5743905328	750

AJ FLOOR

Floor lamps

Design: Arne Jacobsen

Concept: The fixture emits downward directed light. The angle of the shade can be adjusted to optimize light distribution. The shade is painted white on the inside to ensure a soft comfortable light.

Finish: Dark green, dark grey, aubergine, light grey, midnight blue, pale petroleum, rusty red, yellow ochre, black or white, wet painted.

Material: Base: Die cast zinc. Shade: Spun steel. Stem: Steel.

Mounting: Cord type: White (White finish), black (non-white finish). Cord length: 9'.
Switch: In-line on/off foot switch provided.

Weight: Max: 8 lbs.

Compliance: cULus, Dry location.

Info notes: The white version is supplied with a white cable. The other versions are supplied with a black cable.



Product Code	Light source	Voltage	Finish	Cable type	Item number	Price
AJ-F	1x15W A-19/medium	120V	Stainless Steel Polished	BLK	5744915113	1.680
AJ-F	1x15W E26		Aubergine	BLK	5744905974	1.430
AJ-F	1x15W E26		Black	BLK	5744905929	1.430
AJ-F	1x15W E26		Dark Green	BLK	5744905990	1.430
AJ-F	1x15W E26		Dark Grey	BLK	5744905987	1.430
AJ-F	1x15W E26		Light Grey	BLK	5744905932	1.430
AJ-F	1x15W E26		Midnight Blue	BLK	5744905961	1.430
AJ-F	1x15W E26		Pale Petroleum	BLK	5744906009	1.430
AJ-F	1x15W E26		Rusty Red	BLK	5744905958	1.430
AJ-F	1x15W E26		White	WHT	5744905916	1.430
AJ-F	1x15W E26		Yellow Ochre	BLK	5744905945	1.430
Sparepart						
FOOT SWITCH, ON/OFF, BLACK					5717000000	58

KEGLEN FLOOR

Floor lamps

Design: Big Ideas

Concept: The floor lamp's distinctive conical shade has a built-in curved diffuser. This ensures an attractive and glare-free downwardly directed light. The stem morphs into the diffuser shade, folding inward and creating a beautiful organic geometry. A gentle light is also emitted upward through a discreet uniform opening in the top of the shade to create a perfect ambiance.

Finish: Black or white, matte, wet-painted.

Material: Shade: Spun aluminum. Diffuser: Injection-molded PC. Base: Die cast aluminum. Stem: Machined aluminum.

Mounting: Cord type: White or black. Cord length: 10'. Switch: Button on the base. LED driver: Separate, plugs into power outlet.

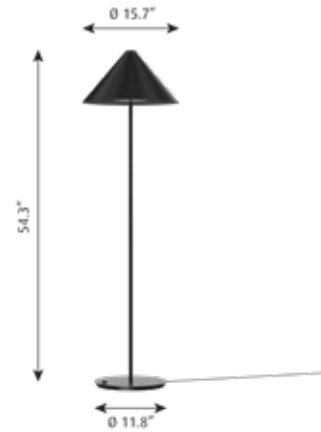

Compliance: cULus, Dry location.

Info notes: An integrated memory function ensures that the lamp will return to its latest adjusted lumen output when power has been removed and restored.

Electrical:

System Wattage: 9W

LED Wattage: 8W

Delivered lumens: 481 - 573

Efficacy: 57 lm/W - 67 lm/W (LED)

Certifications:

cULus, Dry Location

Protection class IP20

Controllability: Continuous dimming by integrated button switch.

Color Rendering: Ra≥90

Dim-to-warm LED CCT: 2700K at 100%; 2000K at max dim

Light source	Finish	Switch/Plug	Cable type	Item number	Price
9W LED/2700-2000K D2W	Black	W/ON/OFF SWITCH	BLK	5744166797	1.396
9W LED/2700-2000K D2W	White	W/ON/OFF SWITCH	WHT	5744166784	1.396
9W LED/3000K	Black	W/ON/OFF SWITCH	BLK	5744167945	1.396
9W LED/3000K	White	W/ON/OFF SWITCH	WHT	5744167958	1.396
Sparepart					
ADAPTOR 12V BLK				5744164867	62
ADAPTOR 12V WHT				5744164870	62
Keglen Floor diffuser				5744167961	70

MOONSETTER

Floor lamps

Design: Anne Boysen

Concept: The sculptural floor lamp in chrome-plated aluminum has a rotating disc that allows customization of the reflection of the glare-free light emitted by the LED light source elegantly submerged in the frame. The disc rotates 360° around its own axis and is white on one side and reflective on the other. Tilted towards the white side, the light becomes soft and diffuse, whereas the opposite chrome side reflects the light panel directly for a completely different expression. The light is directed according to the position of the disc. The surroundings are mirrored in the frame and the chrome side of the disc. The lamp offers stepless dimming and is turned on and off by the rotating footswitch on the cylinder.

Finish: High lustre chrome-plated.

Disc: High lustre chrome-plated on one side and white, wet painted on the opposite side.

Material: Frame: High lustre chrome-plated solid cast aluminum.
 Cylinder and switch: High lustre chrome-plated extruded aluminum.
 Disc: Solid cast aluminum. High lustre chrome-plated on one side and white on the opposite side.
 Opal silicone diffuser.

Mounting: Cable type: Black PVC. Cable length: 8'.
 LED-driver: Separate, plugs into power outlet.
 Light control: dial on cylinder of frame.
 Continuous dimming to off.

Compliance: cULus, Dry location.

Info notes: Electrical:
 System Wattage: 19W
 LED Wattage: 18W

Certifications:
 cULus, Dry Location
 Protection class IP20
Controllability: Continuous dimming to off by dial switch on cylinder.
Color Rendering: Ra≥90

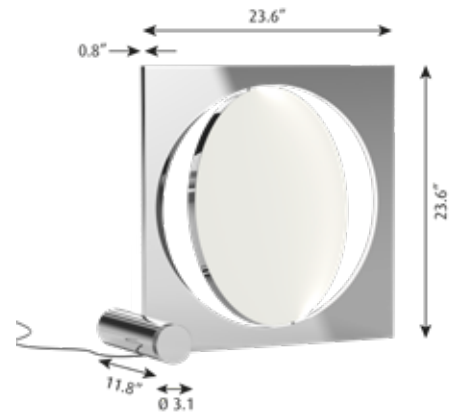

Product Code	Dimensions	Light source	Finish	Switch/Plug	Item number	Price
MNS	600x600	LED 3500K 16W	High Lustre Chrome/White	W/DIMMER	5744908887	9.458

NJP FLOOR

Floor lamps

Design: nendo

Concept: The fixture provides direct glare-free horizontal light while reflecting some of the light through the rear of the head, illuminating the top of the arm. The ergonomic design of the fixture head shapes the light and gives optimal light direction. A simple mechanical system provides great freedom of movement, so the light can always be set in the ideal position in the workspace. The shade is painted white on the inside, reflecting comfortable diffused light.

Finish: White, Black or Light Aluminium Grey, powder coated.

Material: Base: Steel. Arms and lamp head: Aluminum. Joints: Anodized Aluminum. Stem: Aluminum.

Mounting: Cord type: White (White finish), black (non-white finish). Cord length: 6'.
Switch: High/low/off button on the fixture head. Timer function: 4 hours or 8 hours.
LED driver: Separate, plugs into power outlet.

Weight: Max: 6 lbs.

Compliance: cULus, Dry location.



Product Code	Light source	Voltage	Finish	Item number	Price
NJP-F	10W LED/2700K	120V	Black	10000135264	974
NJP-F	10W LED/2700K	120V	Light Aluminum Grey	10000142407	974
NJP-F	10W LED/2700K	120V	White	10000135266	974
NJP-F	10W LED/3000K	120V	Black	10000135267	974
NJP-F	10W LED/3000K	120V	Light Aluminum Grey	10000138380	974
NJP-F	10W LED/3000K	120V	White	10000135268	974
Sparepart					
ADAPTOR 12V BLK				5744164867	62
ADAPTOR 12V WHT				5744164870	62

PANTHELLA FLOOR

Floor lamps

Design: Verner Panton

Concept: The fixture emits a soft and comfortable illumination. The hemispherical shade reflects the light downwards, and the material used ensures that the majority of the light is spread diffusely in the room from the surface of the shade.

Finish: White, opal acrylic.

Material: Base: White, injection molded ABS. Shade: Injection molded white opal acrylic. Housing: White, injection molded ABS. Stem: White, steel.

Mounting: Cord type: White. Cord length: 11'. Switch: In-line on/off foot switch provided.

Weight: Max: 13 lbs.

Compliance: cULus, Dry location.



Product Code	Light source	Voltage	Finish	Item number	Price
PAN-F	1x22W A-21/IF medium	120V	White Opal Acrylic	10000155551	1.298
Sparepart					
PANTHELLA FLOOR UPPER TRUMPET				5744163305	150
PANTHELLA FLOOR LEGS WITH NUT & WASHER				5744610531	66

PH 3½-2½ FLOOR

Floor lamps

Design: Poul Henningsen

Concept: The fixture is designed based on the principle of a reflective three-shade system, which directs the majority of the light downwards. The shades are made of handblown opal three-layer glass, which is glossy on top and sandblasted matte on the underside, giving a soft and diffused light distribution.

Finish: Black metalized or high lustre chrome plated. White opal glass.

Material: Base: Black metalized or high lustre chrome plated, spun brass. Shades: Hand blown white opal glass. Top plate: Black metalized or high lustre chrome plated, spun brass. Stem: Black metalized or high lustre chrome plated, steel.

Mounting: Cord type: Black. Cord length: 12'. Switch: In-line on/off foot switch provided.

Weight: Max: 16 lbs.

Compliance: cULus, Dry location.



Product Code	Light source	Voltage	Finish	Cable type	Item number	Price
PH3½-2½-F	1x15W A-19/medium	120V	Black Metalized	BLK	5744903879	2.458
PH3½-2½-F	1x15W A-19/medium	120V	Brass Metalized	WHT	5744902032	2.458
PH3½-2½-F	1x15W A-19/medium	120V	High Lustre Chrome Plated	BLK	5744901376	2.252
Sparepart						
FOOT SWITCH, ON/OFF, BLACK					5717000000	58

PH 4¹/₂-3¹/₂ GLASS FLOOR

Floor lamps

Design: Poul Henningsen

Concept: The fixture is designed based on the principle of a reflective three-shade system, which directs the majority of the light downwards. The shades are made of hand blown opal three-layer glass, which is glossy on top and sandblasted matte on the underside, giving a soft and diffused light distribution.

Finish: High lustre chrome plated. White opal glass.

Material: Base: High lustre chrome plated, spun brass. Shades: Hand blown white opal glass. Anti-glare ring: Purple, spun aluminum. Top plate: High lustre chrome plated, spun brass. Stem: High lustre chrome plated, steel.

Mounting: Cord type: Black. Cord length: 7'. Switch: In-line on/off foot switch provided.

Weight: Max: 36 lbs.

Compliance: cULus, Dry location.



Product Code	Light source	Voltage	Finish	Item number	Price
PH4 ¹ / ₂ -3 ¹ / ₂ -F	1x15W A-19/IF medium	120V	High Lustre Chrome Plated	5844901266	4.504
Sparepart					
FOOT SWITCH, ON/OFF, BLACK				571700000	58

PH 80

Floor lamps

Design: Poul Henningsen

Concept: The fixture emits a diffused, reflected, symmetrical light. The majority of the light is directed downward. The opal acrylic shades provide comfortable room lighting. On the original fixture, the red hue of the top reflector adds an intense, warm glow to the light. The black and white fixtures have a white top reflector that reflects the light for a clean, elegant look. The choice of light source will determine the color of the illumination.

Finish: White opal acrylic shades.
 High lustre chrome plated stand with black, textured base.
 Black stand with black, smooth base.
 White stand with white, smooth base.
 Chrome variant has a red top reflector.
 Black and white variants have a white top reflector.

Material: Shades: High pressure molded white opal acrylic. Top reflector: Red or White polycarbonate. Top cover and base: Black or white, high pressure molded ABS. Stand: High lustre chrome plated or black or white, powder coated, steel.

Mounting: Cord type: Black. Cable length: 9'. Switch: In-line dimming foot switch provided.

Weight: Max: 17 lbs.

Compliance: cULus, Dry location.

Info notes: Electrical:
 System Wattage: 70W
 Delivered lumens: 572 lm
 Efficacy: <10 lm/W
 Certifications:
 cULus, Dry Location
 Protection class IP20
 Color Rendering: Ra≥90
 Actual performance dependent upon screw-base lamp used.

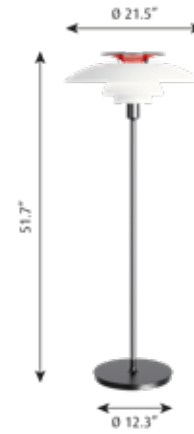

Light source	Voltage	Finish	Switch/Plug	Item number	Price
1x70W A-21/CL medium	120V	White Opal Acrylic/Black	W/DIMMER	10000157285	1.824
1x70W A-21/CL medium	120V	White Opal Acrylic/High Lustre Chrome Plated	W/DIMMER	10000157284	Contact LP
1x70W A-21/CL medium	120V	White Opal Acrylic/White	W/DIMMER	10000157283	1.824
Sparepart					
PH 80, LOWER SHADE				5744610641	104
PH 80, MIDDLE SHADE				5744610638	122
PH 80, SOCKET COVER W/BRANCH				5744610654	154
PH 80 SOCKET COVER W/BRANCH BLK				5744611543	162
PH 80 SOCKET COVER W/BRANCH WHT				5744611569	162
PH 80, TOP ROUGE/BLACK				5744610667	176
PH 80 TOP WHITE/BLACK				5744611530	184
PH 80 TOP WHITE/WHITE				5744611556	184
PH 80, TOP SHADE				5744610298	264
FOOT SWITCH, ON/OFF, BLACK				5717000000	58
PH 80 FLOOR, REBUILDING SET				5744610793	Contact LP

VL STUDIO TABLE/FLOOR

Floor lamps, Table lamps

Design: Vilhelm Lauritzen

Concept: The fixture emits a diffused, glare-free light. The triple-layered opal glass provides a comfortable light distribution and radiates a pleasantly delicate glow to its surroundings.

Finish: Matte-black, wet-painted; or brushed brass with fine hairlines. White opal glass, glossy. Clear-lacquered brass.

Material: Glass: Hand-blown, opal, triple-layered, glossy.
Housing: Deep-drawn aluminum or brass.

Mounting: Cable type: Black for black version and white on brass versions.
Cable length: 8.2 ft. In-line switch.
Ø250: On/off switch on cable.
Ø250 and Ø320: Electronic dimmer switch (requires dimmable lamp).
Glass shade can be removed to change the lamp.

Weight: Max. 7,9 kg.

Compliance: cULus, Dry location.

Info notes: The untreated brass will change over time and develop a patina.

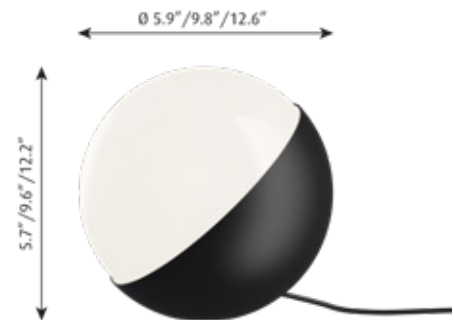

Dimensions	Light source	Voltage	Finish	Switch/Plug	Cable type	Item number	Price	
12.6 IN	1x15W A-19/medium	120V	Black	W/DIMMER	BLK	5744908078	1.010	
12.6 IN	1x15W A-19/medium	120V	Lacquered Brass	W/DIMMER	WHT	5744908120	1.430	
5.9 IN	1x5W 30W G9	120V	Black	W/ON/OFF SWITCH	BLK	5744907875	470	
5.9 IN	1x5W 30W G9	120V	Lacquered Brass	W/ON/OFF SWITCH	WHT	5744907914	618	
9.8 IN			Black	W/DIMMER	BLK	5744907956	662	
9.8 IN	1x15W A-19/medium	120V	Lacquered Brass	W/DIMMER	WHT	5744907998	1.036	
Sparepart								
VL STUDIO 250 TABLE GLASS						5744167851	244	
VL STUDIO 320 TABLE GLASS						5744167864	412	
VL STUDIO TABLE/WALL GROMMET WHITE						5744167877	6	
VL STUDIO TABLE/WALL GROMMET BLACK						5744167880	6	

VL38 FLOOR

Floor lamps

Design: Vilhelm Lauritzen

Concept: The fixture emits downward directed light. The angle of the shade can be adjusted to optimize light distribution. The shade is painted white on the inside to ensure a soft comfortable light.

Finish: Brushed brass. Black or white, powder coated.

Material: Base: Die cast aluminum. Shade: Spun aluminum. Stem: Brushed brass.

Mounting: Cord type: White or black. Cord length: 10'. Switch: In-line High/low/off foot switch provided. LED driver: Separate, plugs into power outlet.

Weight: Max: 5 lbs.

Compliance: cULus, Dry location.

Info notes: Please note that the brass surfaces are untreated. This means that the surface will change over time and develop a patina.



Product Code	Light source	Voltage	Finish	Item number	Price
VL38-F	10W LED/2700K	120V	Black	5744163208	974
VL38-F	10W LED/2700K	120V	White	5744162270	974
Sparepart					
VL38 REPLACEMENT KIT LED W/WIRE				5744165963	26
ADAPTOR 12V BLK				5744164867	62
ADAPTOR 12V WHT				5744164870	62

YUH FLOOR

Floor lamps

Design: GamFratesi

Concept: The fixture primarily provides glare-free downward directed light. The angle of the shade can be adjusted to optimize light distribution. A slim opening in the top of the shade provides soft, ambient upward illumination. A mechanical system provides great freedom of movement, so the light can always be set in the ideal position in the workspace, living room etc. Built-in LED technology provides a high quality of light with stepless dimming from 100% to 15%. Optional timer capability automatically turns off the light after a chosen duration of 4 or 8 hours. Returns to the last dim level setting when switched on. A button at the top of the tube acts as switch and dimmer.

Finish: White or black. Matte wet painted. Brass/Marble versions: White or black shade. Matte wet painted. Clear lacquered, brushed brass stem. Matte marble base.

Material: Shade: Die cast aluminum. Base: Die cast aluminum (wet painted) or brushed marble. Marble: Italian Nero Margiua or White Carrara. Stem: Extruded brass (wet painted or clear lacquered).

Mounting: Cord type: White or black. Cord length: 10'. Switch: High/low/off switch on the base. LED driver: Separate, plugs into power outlet.

Weight: Max: 5 lbs.

Compliance: cULus, Dry location.



Product Code	Light source	Voltage	Finish	Mounting	Item number	Price
YUH-F	10W LED/2700K	120V	Black	BLACK BASE	5744612539	974
YUH-F	10W LED/2700K	120V	Brass/Black	BLACK MARBLE BASE	5744162678	1.162
YUH-F	10W LED/2700K	120V	Brass/White	WHITE MARBLE BASE	5744162681	1.162
YUH-F	10W LED/2700K	120V	White	WHITE BASE	5744612542	974
Sparepart						
ADAPTOR 12V BLK					5744164867	62
ADAPTOR 12V WHT					5744164870	62

AJ 50 WALL

Wall and Ceiling Outdoor

Design: Arne Jacobsen

Concept: The fixture emits downward directed light. The shade is painted white on the inside to ensure a soft comfortable light distribution.

Finish: Black, white or natural painted aluminum, textured powder coated.

Material: Back plate: Die cast aluminum. Shade: Die cast aluminum. LED enclosure: frosted glass.

Mounting: Surface: Mounted directly to finished surface over a 4" octagonal junction box.

Weight: Max: 4 lbs.

Compliance: cULus, Wet location.

Info notes: Electrical:
 System Wattage: 9 W
 LED Wattage: 8 W
 Delivered lumens: 504 lm
 Efficacy: 56.0 lm/W

Certifications:
 cULus, Wet Location
 Protection class IP65
 IK class 06
 BUG Rating: B0-U1-G0
 Controllability: Phase dimming
 Min.-Max. Ambient Temp: -30°C to +40°C
 Color Rendering: Ra≥90

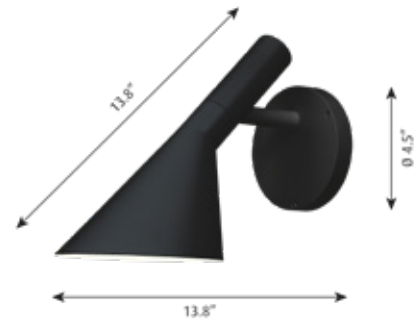

Product Code	Light source	Voltage	Finish	Item number	Price
AJ50	9W LED/3000K	120V	Black Texture	5743909544	1.588
AJ50	9W LED/3000K	120V	Natural Paint Aluminum	5743909560	1.588
AJ50	9W LED/3000K	120V	White Texture	5743909557	1.588

AJ EKLIPTA OUTDOOR

Wall and Ceiling Outdoor

Design: Arne Jacobsen

Concept: The fixture emits soft comfortable light. The glass is designed to provide a uniformly lit surface. The three-layer hand blown opal glass shade has a transparent edge, providing a decorative halo of light around the fixture.

Finish: White, powder coated. White opal glass.

Material: Ceiling/Wall box: Spun aluminum. Diffuser: Hand blown white opal glass.

Mounting: Surface: Mounted directly to finished surface over a recessed 4" octagonal junction box (13.7"/17.7") or 3" octagonal junction box (8.7").

Weight: Max: 11 lbs.

Compliance: cULus, Wet location.

Info notes: Electrical:

LED System Wattage: 10W or 24W

LED Wattage: 9W or 22W

Delivered lumens: 371 - 1,937

Efficacy: 37.1 lm/W - 80.7 lm/W

Certifications: cULus, Wet Location (Incandescent variants), Damp location (LED variants)

Protection class IP20

Controllability: 0-10V Dimming, Phase Dimming

Color Rendering: Ra≥90

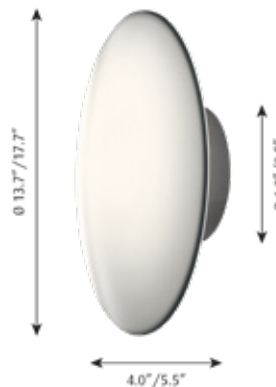

Product Code	Dimensions	Light source	Voltage	Finish	Mounting	Item number	Price
AJE	13.7 IN	1x60W A-19/IF medium	120V	White	WALL AND SURFACE	5842905400	778
AJE	17.7 IN	1x100W A-19/IF medium	120V	White	WALL AND SURFACE	5842905426	1.038
AJE	8.7 IN	1x40W 30W G9	120V	White	WALL AND SURFACE	5743908011	664

FLINDT WALL

Wall and Ceiling Outdoor

Design: Christian Flindt

Concept: The fixture emits an asymmetrical glare-free, downward directed light distribution. Softly illuminating its cut-out shape while providing an efficient horizontal illumination on the ground or floor. Perfectly fit for indoor as well as outdoor applications.

Finish: Corten color, natural painted aluminum or white, powder coated.

Material: Front and back housing: Die cast aluminum.
Light Engine: Die cast aluminum and injection molded acrylic.

Mounting: Surface: Mounted directly to finished surface over a recessed 3 inch octagonal junction box (7.9 IN) or 4 inch octagonal junction box (11.8 IN/15.7 IN).

Weight: Max: 12 lbs.

Compliance: cULus, Wet location.

Info notes: Electrical:
System Wattage: 10 - 30 W
LED Wattage: 9 - 28 W
Delivered lumens: 336 lm - 1,052 lm
Efficacy: 33.6 - 35.1 lm/W

Certifications:
cULus, Wet Location
Protection class IP65
IK class 08 (7.9IN); 09 (11.8IN & 15.7IN)
BUG Rating: B0-U3-G1
Controllability: 0-10V Dimming
Min.-Max. Ambient Temp: -20°C to +40°C
Color Rendering: Ra≥90

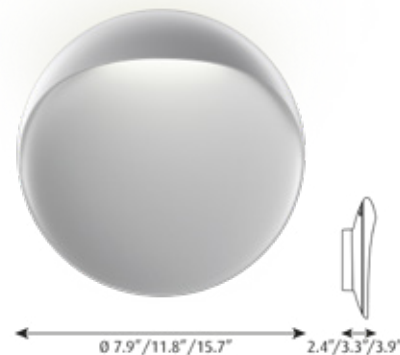

Product Code	Dimensions	Light source	Voltage	Finish	Lighting control	Item number	Price
FLINDT-W	11.8 IN	30W LED/2700K	120-277V/60HZ	Corten Color	DIM 0-10V	5747912786	1.152
FLINDT-W	11.8 IN	30W LED/2700K	120-277V/60HZ	Natural Paint Aluminum	DIM 0-10V	5747912744	1.152
FLINDT-W	11.8 IN	30W LED/2700K	120-277V/60HZ	White Texture	DIM 0-10V	5747912825	1.152
FLINDT-W	11.8 IN	30W LED/3000K	120-277V/60HZ	Corten Color	DIM 0-10V	5747912799	1.152
FLINDT-W	11.8 IN	30W LED/3000K	120-277V/60HZ	Natural Paint Aluminum	DIM 0-10V	5747912757	1.152
FLINDT-W	11.8 IN	30W LED/3000K	120-277V/60HZ	White Texture	DIM 0-10V	5747912838	1.152
FLINDT-W	15.7 IN	30W LED/2700K	120-277V/60HZ	Corten Color	DIM 0-10V	5747912906	1.524
FLINDT-W	15.7 IN	30W LED/2700K	120-277V/60HZ	Natural Paint Aluminum	DIM 0-10V	5747912867	1.524
FLINDT-W	15.7 IN	30W LED/2700K	120-277V/60HZ	White Texture	DIM 0-10V	5747912948	1.524
FLINDT-W	15.7 IN	30W LED/3000K	120-277V/60HZ	Corten Color	DIM 0-10V	5747912919	1.524
FLINDT-W	15.7 IN	30W LED/3000K	120-277V/60HZ	Natural Paint Aluminum	DIM 0-10V	5747912870	1.524
FLINDT-W	15.7 IN	30W LED/3000K	120-277V/60HZ	White Texture	DIM 0-10V	5747912951	1.524
FLINDT-W	7.9 IN	10W LED/2700K	120-277V/60HZ	Corten Color	PHASE DIMMING (MAINS DIMM)	5747912663	854
FLINDT-W	7.9 IN	10W LED/2700K	120-277V/60HZ	Natural Paint Aluminum	PHASE DIMMING (MAINS DIMM)	5747912621	854
FLINDT-W	7.9 IN	10W LED/2700K	120-277V/60HZ	White Texture	PHASE DIMMING (MAINS DIMM)	5747912702	854
FLINDT-W	7.9 IN	10W LED/3000K	120-277V/60HZ	Corten Color	PHASE DIMMING (MAINS DIMM)	5747912676	854
FLINDT-W	7.9 IN	10W LED/3000K	120-277V/60HZ	Natural Paint Aluminum	PHASE DIMMING (MAINS DIMM)	5747912634	854
FLINDT-W	7.9 IN	10W LED/3000K	120-277V/60HZ	White Texture	PHASE DIMMING (MAINS DIMM)	5747912715	854

NYHAVN WALL

Wall and Ceiling Outdoor

Design: Alfred Homann & Ole V. Kjær

Concept: The conical shade ensures comfortable light that is directed downwards in a wide beam. The shade interior has a white matte painted surface, ensuring uniform light distribution. The rings ensure that a stray light is controlled, and direct a small amount of light onto the top side of the shade for self-illumination.

Finish: Copper, brushed or white, wet painted.

Material: Shades: Spun aluminum or spun copper. Diffuser: Clear glass. Top: Spun aluminum or spun copper. Mounting box: Die cast aluminum. Mounting box cover: Spun aluminum or spun copper. Arm: Copper plated, red brass or steel.

Mounting: Surface: Mounted directly to finished surface over a recessed 4" octagonal junction box.

Weight: Max: 11 lbs.

Compliance: cULus, Wet location.

Info notes: Electrical:

System Wattage: 15 W

Delivered lumens: 1,239 lm

Efficacy: 82.6 lm/W

Certifications:

cULus, Wet Location

Protection class IP44

BUG Rating: B1-U2-G0

Controllability: Phase dimming

Min.-Max. Ambient Temp: -20°C to +40°C

Actual performance dependent upon screw-base lamp used.

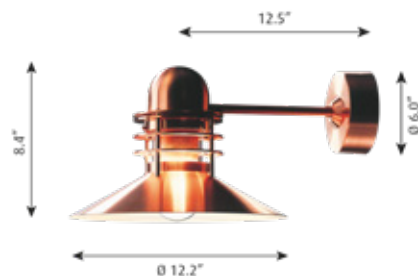

Product Code	Light source	Voltage	Finish	Shield/Diffuser	Item number	Price
NW	1x15W A-19/medium	120V	Brushed Copper	CLEAR	5743909379	2.750
NW	1x15W A-19/medium	120V	White	CLEAR	5743909366	2.106

PH 3-2½ WALL

Wall and Ceiling Outdoor

Design: Poul Henningsen

Concept: The fixture is designed based on the principle of a reflective three-shade system, which directs the majority of the light downwards. The shades have a matte white painted interior surface, diffusing the light in a comfortable way.

Finish: Black, powder coated.

Material: Top shade: Spun stainless steel. Middle/lower shade: Spun stainless steel. Shadeholder: Die formed glass. Mounting plate: Die cast aluminum. Mounting plate cover: Spun aluminum. Arm: Stainless steel.

Mounting: Surface: Mounted directly to finished surface over a recessed 4" octagonal junction box.

Weight: Max: 6 lbs.

Compliance: cULus, Wet location.

Info notes: Electrical:
 System Wattage: 15 W
 Delivered lumens: 720 lm
 Efficacy: 48.0 lm/W

Certifications:
 cULus, Wet Location
 Protection class IP44
 BUG Rating: B0-U3-G1
 Controllability: Phase dimming
 Min.-Max. Ambient Temp: -20°C to +40°C
 Actual performance dependent upon screw-base lamp used.



Product Code	Light source	Voltage	Finish	Item number	Price
PH3-2½W	1x15W A-19/medium	120V	Black	5743900022	1.332

PH WALL

Wall and Ceiling Outdoor

Design: Poul Henningsen

Concept: The fixture is designed based on the principle of a reflective three-shade system, which directs the light downwards. The shades have a matte white painted inside to ensure diffuse, comfortable light distribution.

Finish: Copper, brushed. Please note that the copper surface is untreated in order to achieve a verdigris finish over time. This can result in an inconsistent surface finish prior to the product achieving full patina. This process might have begun already during stocking/ transportation.

Material: Shades: Spun copper. Wall box: Spun copper. Arm: Copper.

Mounting: Surface: Mounted directly to finished surface over a recessed 4" octagonal junction box. Requires three bolts on 5.2IN circle.

Compliance: cULus, Wet location.

Info notes: Electrical: System Wattage: 15 W Delivered lumens: 735 lm Efficacy: 49 lm/W Certifications: cULus, Wet Location Protection class IP23 BUG Rating: B0-U1-G0 Controllability: Phase dimming Min.-Max. Ambient Temp: -20°C to +40°C Actual performance dependent upon screw-base lamp used.

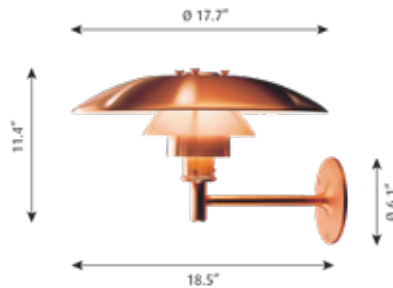

Light source	Voltage	Finish	Item number	Price
1x15W E26	120V	Brushed Copper	5743909489	3.038

SKOT WALL

Wall and Ceiling Outdoor

Design: LK as

Concept: The fixture is available with two types of distribution: symmetric or asymmetric. The asymmetric is only recommended for wall mounting. The opal diffuser creates a soft light distribution.

Finish: Natural painted aluminum or silver, powder coated.

Material: Diffuser: Injection molded white opal polycarbonate. Base/cross guard: Die cast aluminum.

Mounting: Surface: Mounted directly to finished surface over a recessed 4" octagonal junction box.

Weight: Max: 7 lbs.

Compliance: cULus, Wet location.

Info notes: Electrical:
 System Wattage: 15 W
 LED Wattage: 14 W
 Delivered lumens: 308 lm - 476 lm
 Efficacy: 20.5 - 31.7 lm/W

Certifications:
 cULus, Wet Location
 Protection class IP66
 IK class 10
 BUG Rating: B1-U2-G1
 Min.-Max. Ambient Temp: -40°C to +40°C
 Color Rendering: Ra≥80
 This product is non-dimming.

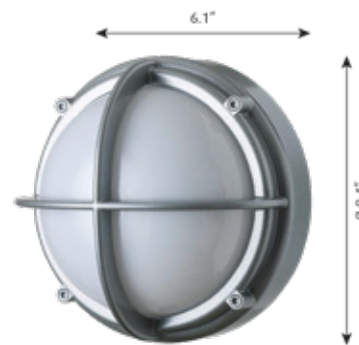

Product Code	Light source	Voltage	Finish	Distribution/Trim	Shield/Diffuser	Item number	Price
SKT	15W LED/3000K	120-277V/60HZ	Natural Paint Aluminum	ASYMMETRIC	OPAL HALF SHADED	5743911516	1.204
SKT	15W LED/3000K	120-277V/60HZ	Natural Paint Aluminum	SYMMETRIC	OPAL	5743911503	1.204
SKT	15W LED/3000K	120-277V/60HZ	Silver Grey	ASYMMETRIC	OPAL HALF SHADED	5743911435	1.204
SKT	15W LED/3000K	120-277V/60HZ	Silver Grey	SYMMETRIC	OPAL	5743911422	1.204
SKT	15W LED/4000K	120-277V/60HZ	Aluminum Color	ASYMMETRIC	OPAL HALF SHADED	5743911477	1.204
SKT	15W LED/4000K	120-277V/60HZ	Natural Paint Aluminum	ASYMMETRIC	OPAL HALF SHADED	5743911558	1.204
SKT	15W LED/4000K	120-277V/60HZ	Natural Paint Aluminum	SYMMETRIC	OPAL	5743911545	1.204
SKT	15W LED/4000K	120-277V/60HZ	Silver Grey	SYMMETRIC	OPAL	5743911464	1.204

TOLDBOD 6.1 WALL

Wall and Ceiling Outdoor

Design: Louis Poulsen A/S

Concept: The light is directed 100% downwards and the shade has a matte white painted interior emitting a soft, diffused, comfortable light.

Finish: Black or natural painted aluminum, powder coated.

Material: Shield: Tempered sand blasted glass. Wall plate: Die cast aluminum. Luminaire head: Die cast aluminum. Arm: Extruded aluminum.

Mounting: Surface: Mounted directly to finished surface over a recessed 4" octagonal junction box.

Weight: Max. 3.5 lbs.

Compliance: cULus, Wet location.

Info notes: Electrical:
System Wattage: 10 W
Delivered lumens: 189 lm
Efficacy: 18.9 lm/W

Certifications:
cULus, Wet Location
Protection class IP44
IK class 05
BUG Rating: B1-U2-G1
Controllability: Phase dimming
Min.-Max. Ambient Temp: -20°C to +40°C
Actual performance dependent upon screw-base lamp used.



Product Code	Light source	Voltage	Finish	Item number	Price
TOW-6.1	1x10W G16.5/IF candelabra	120V	Black Texture	5743911736	760
TOW-6.1	1x10W G16.5/IF candelabra	120V	Natural Paint Aluminum	5743911723	760

AJ GARDEN BOLLARD

Bollard

Design: Arne Jacobsen

Concept: This outdoor lamp emits a pleasant, fully shaded, downwardly directed, glare-free light. It is available in two different heights and has a fixed head. The inside of the shade is painted white to ensure a soft and pleasant reflection of light. The shape of the shade provides superior lighting, allowing an optimal view of its surroundings. The garden bollard can be fitted with three different installation types – namely a base plate, a spike, or an anchor.

Finish: Outside: Black textured surface, powder-coated.
 Inside: White, wet-painted.

Material: Head: Cast aluminum. Stem and base plate: Stainless steel.
 Spike: Cast aluminum with ABS housing.
 Anchor: Steel.
 Diffuser: Injection-molded opal PC.

Mounting: The bollard requires a separate, 24V DC power supply.
 Choice of 3 different mounting types.

Spike mounted bollard: For use in soil or gravel; includes weather-proof cables and connectors for above-ground runs. Plug and play.
Anchor mounted bollard: for casting in new concrete pad.
Base mounted bollard: Includes baseplate for anchoring to decks and floors.

Anchor or Base mounted bollards: installation determined by certified electrician with below ground cabling and conduit.

Weight: Max. 4 lbs.

Compliance: Ingress protection: IP 65. IK06

Info notes: The adapter is positioned externally from the fixture and can run up to 6 bollards. Maximum distance to last bollard is 30m.

Spike: Plug and play. Let the enclosed cables run over the ground. Uses standard cables and connectors which are supplied.
Anchor/Base: Requires certified electrician. Use installation tube for inground installation, with enclosed cables running inside, for legal fixed installation.

LED replacement kit available. Replacement of the built-in LED requires a certified electrician.

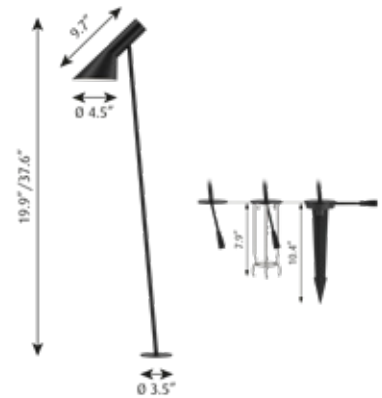

Product Code	Dimensions	Light source	Finish	Mounting	Item number	Price
AJG-B	LONG	LED 2700K	Black Texture	Base w/o power supply	10000163723	994
AJG-B	LONG	LED 2700K	Black Texture	Anchor w/o power supply	10000163726	1.062
AJG-B	LONG	LED 3000K	Black Texture	Spike w/o power supply	10000163689	1.014
AJG-B	LONG	LED 3000K	Black Texture	Base w/o power supply	10000163722	994
AJG-B	LONG	LED 3000K	Black Texture	Anchor w/o power supply	10000163725	1.062
AJG-B	LONG	LED 4000K	Black Texture	Spike w/o power supply	10000163688	1.014
AJG-B	LONG	LED 4000K	Black Texture	Anchor w/o power supply	10000163724	1.062
AJG-B	LONG	LED 4000K	Black Texture	Base w/o power supply	10000163721	994
AJG-B	SHORT	LED 2700K	Black Texture	Spike w/o power supply	10000163687	952
AJG-B	SHORT	LED 2700K	Black Texture	Base w/o power supply	10000163729	930
AJG-B	SHORT	LED 2700K	Black Texture	Anchor w/o power supply	10000163732	998
AJG-B	SHORT	LED 3000K	Black Texture	Spike w/o power supply	10000163686	952
AJG-B	SHORT	LED 3000K	Black Texture	Base w/o power supply	10000163728	930
AJG-B	SHORT	LED 3000K	Black Texture	Anchor w/o power supply	10000163731	998
AJG-B	SHORT	LED 4000K	Black Texture	Spike w/o power supply	10000163685	952
AJG-B	SHORT	LED 4000K	Black Texture	Base w/o power supply	10000163727	930
AJG-B	SHORT	LED 4000K	Black Texture	Anchor w/o power supply	10000163730	998

Sparepart

AJ GARDEN REP:KIT COB/PCB 4K					5747406221	122
------------------------------	--	--	--	--	------------	-----

Sparepart

AJ GARDEN REP:KIT COB/PCB 3K	5747406234	122
AJ GARDEN REP:KIT COB/PCB 27K	5747406247	122
AJ GARDEN DIFFUSER KIT	5747407055	14
Power Supply for Base & Anchor Mount, 24VDC 100W 120-277V Input	10000158964	232
T-Connector for Spike-Mount Garden Bollards	5747405303	26
Extension Cable 16.4 Ft For Spike-Mount Garden Bollards	5747405316	74
AJ GARDEN SPIKE+BASE BLK + SCREWS	5747406205	74
AJ GARDEN SPARE BASE SCREWS (4 pcs)	5747406218	8
AJ GARDEN ANCHOR + SCREWS/WASHERS	5747406195	96

Accessories

Power Supply with Cords for Spike Mount, 24VDC 100W 120V Input	10000158965	Contact LP
--	-------------	------------

BYSTED GARDEN BOLLARD

Bollard

Design: Peter Bysted

Concept: The fixture has a round symmetrical design with four rings reflecting the light in a soft downward direction. The rings have a soft glow while their white undersides achieve optimal light reflection and produce a characteristic symmetrical light pattern on the ground.

Finish: Top: Cast aluminum. Reflector part: Cast aluminum. Post: Extruded aluminum. Base plate, spike, and anchor: Cast aluminum. Diffuser: PC

Material: Top: Cast aluminum. Reflector part: Cast aluminum. Post: Extruded aluminum. Base plate, spike, and anchor: Cast aluminum. Diffuser: PC

Mounting: The bollard requires a separate, 24V DC power supply. Choice of 3 different mounting types.

Spike mounted bollard: For use in soil or gravel; includes weather-proof cables and connectors for above-ground runs. Plug and play.

Anchor mounted bollard: for casting in new concrete pad.

Base mounted bollard: Includes baseplate for anchoring to decks and floors.

Anchor or Base mounted bollards: installation determined by certified electrician with below ground cabling and conduit.

Weight: Max. 6 kg.

Compliance: cULus, Wet location.

Info notes: Electrical:

System Wattage: 14W

LED Wattage: 13W

Delivered lumens: 247 - 324 lm

Efficacy: 18 - 23 lm/W

Certifications: cULus, Wet Location

Protection class IP65

IK class 06

BUG Rating: B0-U2-G0

Color Rendering: Ra≥80

LED is non-dimming.

Low Voltage power supply 24VDC is remote mounted for multiple bollards per supply. Spike mounted bollards use provided weather-proof cables and connectors for above-ground runs. Plug and play. Anchor or Base mounted bollards: installation determined by certified electrician with below ground cabling and conduit. Consult factory for remote power supply information, maximum bollards and cable distances.

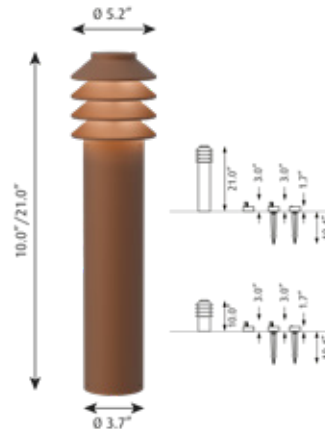

Dimensions	Light source	Voltage	Finish	Mounting	Item number	Price
LONG	14W LED/2700K	24V	Corten Color	Base w/o power supply	5747404579	640
LONG	14W LED/2700K	24V	Corten Color	Anchor w/o power supply	5747404595	694
LONG	14W LED/2700K	24V	Natural Paint Aluminum	Base w/o power supply	5747404919	640
LONG	14W LED/2700K	24V	Natural Paint Aluminum	Anchor w/o power supply	5747404948	694
LONG	14W LED/3000K	24V	Corten Color	Anchor w/o power supply	5747404582	694
LONG	14W LED/3000K	24V	Corten Color	Base w/o power supply	5747404566	640
LONG	14W LED/3000K	24V	Natural Paint Aluminum	Base w/o power supply	5747404906	640
LONG	14W LED/3000K	24V	Natural Paint Aluminum	Anchor w/o power supply	5747404935	694
LONG	14W LED/4000K	24V	Natural Paint Aluminum	Base w/o power supply	5747404896	640
LONG	14W LED/4000K	24V	Natural Paint Aluminum	Anchor w/o power supply	5747404922	694
SHORT	14W LED/2700K	24V	Corten Color	Base w/o power supply	5747404511	586
SHORT	14W LED/2700K	24V	Corten Color	Anchor w/o power supply	5747404537	640
SHORT	14W LED/2700K	24V	Natural Paint Aluminum	Base w/o power supply	5747404825	586
SHORT	14W LED/2700K	24V	Natural Paint Aluminum	Anchor w/o power supply	5747404854	640
SHORT	14W LED/3000K	24V	Corten Color	Base w/o power supply	5747404508	586
SHORT	14W LED/3000K	24V	Corten Color	Anchor w/o power supply	5747404524	640

Dimensions	Light source	Voltage	Finish	Mounting	Item number	Price
SHORT	14W LED/3000K	24V	Natural Paint Aluminum	Base w/o power supply	5747404812	586
SHORT	14W LED/3000K	24V	Natural Paint Aluminum	Anchor w/o power supply	5747404841	640
SHORT	14W LED/4000K	24V	Natural Paint Aluminum	Base w/o power supply	5747404809	586
SHORT	14W LED/4000K	24V	Natural Paint Aluminum	Anchor w/o power supply	5747404838	640
Sparepart						
Power Supply for Base & Anchor Mount, 24VDC 100W 120-277V Input					10000158964	232
T-Connector for Spike-Mount Garden Bollards					5747405303	26
Extension Cable 16.4 FT For Spike-Mount Garden Bollards					5747405316	74
Accessories						
Power Supply with Cords for Spike Mount, 24VDC 100W 120V Input					10000158965	Contact LP

FLINDT GARDEN BOLLARD

Bollard

Design: Christian Flindt

Concept: The fixture emits a wide downward directed glare-free light. The light source rests at the top inside the asymmetric carving on the side of the bollard, where the gradient serves as a reflector that softens the light and forms a pleasant organic shape on the ground below.

Finish: Natural painted aluminum or corten colored. Textured surface, powder coated.

Material: Top: Cast aluminum. Reflector part: Cast aluminum. Post: Extruded aluminum. Base plate: Cast aluminum.

Mounting: The bollard requires a separate, 24V DC power supply. Choice of 3 different mounting types.

Spike mounted bollard: For use in soil or gravel; includes weather-proof cables and connectors for above-ground runs. Plug and play.

Anchor mounted bollard: for casting in new concrete pad.

Base mounted bollard: Includes baseplate for anchoring to decks and floors.

Anchor or Base mounted bollards: installation determined by certified electrician with below ground cabling and conduit.

Compliance: cULus, Wet location.

Info notes: Electrical:

System Wattage: 6.5W

LED Wattage: 6.0W

Delivered lumens: 215-291 lm

Efficacy: 33.1 - 44.7 lm/W

Certifications:

cULus, Wet Location

Protection class IP65

IK class 06

BUG Rating: B0-U2-G0

Color Rendering: Ra≥80

LED is non-dimming.

Low Voltage power supply 24VDC is remote mounted for multiple bollards per supply.

Spike mounted bollards use provided weather-proof cables and connectors for above-ground runs. Plug and play.

Anchor or Base mounted bollards: installation determined by certified electrician with below ground cabling and conduit. Consult factory for remote power supply information; maximum bollards and cable distances.

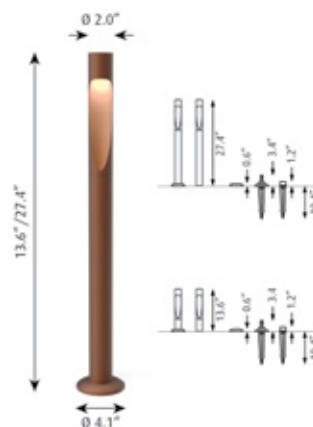

Dimensions	Light source	Voltage	Finish	Mounting	Item number	Price
LONG	7W LED/2700K	24V	Corten Color	Spike w/o power supply	10000158335	498
LONG	7W LED/2700K	24V	Corten Color	Base w/o power supply	5747402571	472
LONG	7W LED/2700K	24V	Corten Color	Anchor w/o power supply	5747402607	518
LONG	7W LED/2700K	24V	Natural Paint Aluminum	Spike w/o power supply	10000158334	498
LONG	7W LED/2700K	24V	Natural Paint Aluminum	Base w/o power supply	5747402937	472
LONG	7W LED/2700K	24V	Natural Paint Aluminum	Anchor w/o power supply	5747402966	518
LONG	7W LED/3000K	24V	Corten Color	Spike w/o power supply	10000158331	498
LONG	7W LED/3000K	24V	Corten Color	Base w/o power supply	5747402568	472
LONG	7W LED/3000K	24V	Corten Color	Anchor w/o power supply	5747402597	518
LONG	7W LED/3000K	24V	Natural Paint Aluminum	Spike w/o power supply	10000158330	498
LONG	7W LED/3000K	24V	Natural Paint Aluminum	Base w/o power supply	5747402924	472
LONG	7W LED/3000K	24V	Natural Paint Aluminum	Anchor w/o power supply	5747402953	518
LONG	7W LED/4000K	24V	Corten Color	Spike w/o power supply	10000158333	498
LONG	7W LED/4000K	24V	Corten Color	Anchor w/o power supply	5747402584	518
LONG	7W LED/4000K	24V	Corten Color	Base w/o power supply	5747402555	472
LONG	7W LED/4000K	24V	Natural Paint Aluminum	Spike w/o power supply	10000158332	498

Dimensions	Light source	Voltage	Finish	Mounting	Item number	Price
LONG	7W LED/4000K	24V	Natural Paint Aluminum	Base w/o power supply	5747402911	472
LONG	7W LED/4000K	24V	Natural Paint Aluminum	Anchor w/o power supply	5747402940	518
SHORT	7W LED/2700K	24V	Corten Color	Spike w/o power supply	10000158341	452
SHORT	7W LED/2700K	24V	Corten Color	Base w/o power supply	5747402487	426
SHORT	7W LED/2700K	24V	Corten Color	Anchor w/o power supply	5747402513	472
SHORT	7W LED/2700K	24V	Natural Paint Aluminum	Spike w/o power supply	10000158340	452
SHORT	7W LED/2700K	24V	Natural Paint Aluminum	Base w/o power supply	5747402843	426
SHORT	7W LED/2700K	24V	Natural Paint Aluminum	Anchor w/o power supply	5747402872	472
SHORT	7W LED/3000K	24V	Corten Color	Spike w/o power supply	10000158337	452
SHORT	7W LED/3000K	24V	Corten Color	Base w/o power supply	5747402474	426
SHORT	7W LED/3000K	24V	Corten Color	Anchor w/o power supply	5747402500	472
SHORT	7W LED/3000K	24V	Natural Paint Aluminum	Spike w/o power supply	10000158336	452
SHORT	7W LED/3000K	24V	Natural Paint Aluminum	Base w/o power supply	5747402830	426
SHORT	7W LED/3000K	24V	Natural Paint Aluminum	Anchor w/o power supply	5747402869	472
SHORT	7W LED/4000K	24V	Corten Color	Spike w/o power supply	10000158339	452
SHORT	7W LED/4000K	24V	Corten Color	Base w/o power supply	5747402461	426
SHORT	7W LED/4000K	24V	Corten Color	Anchor w/o power supply	5747402490	472
SHORT	7W LED/4000K	24V	Natural Paint Aluminum	Spike w/o power supply	10000158338	452
SHORT	7W LED/4000K	24V	Natural Paint Aluminum	Base w/o power supply	5747402827	426
SHORT	7W LED/4000K	24V	Natural Paint Aluminum	Anchor w/o power supply	5747402856	472
Sparepart						
Power Supply for Base & Anchor Mount, 24VDC 100W 120-277V Input					10000158964	232
T-Connector for Spike-Mount Garden Bollards					5747405303	26
Extension Cable 16.4 Ft For Spike-Mount Garden Bollards					5747405316	74
Accessories						
Power Supply with Cords for Spike Mount, 24VDC 100W 120V Input					10000158965	Contact LP

PH 3-2½ BOLLARD

Bollard

Design: Poul Henningsen

Concept: The fixture is designed based on the principle of a reflective three-shade system, which directs the majority of the light downwards. The shades have a matte white painted interior surface, diffusing the light in a comfortable way.

Finish: Black, powder coated.

Material: Top shade: Spun stainless steel. Middle/lower shade: Spun stainless steel. Shadeholder: Die formed glass. Post: Stainless steel. Base plate: Stainless steel.

Mounting: Base plate dimension: 6" diameter. Base plate: Mounted to a concrete base with 3 anchor bolts on a bolt circle of 3.54" diameter. Installation: Refer to mounting instruction download for installation details.

Weight: Max: 8 lbs.

Compliance: cULus, Wet location.

Info notes: Electrical:
 Maximum Lamp Wattage: 60W
 Delivered lumens: 720 lm
 Efficacy: 12.0 lm/W

Certifications:
 cULus, Wet Location
 Protection class IP65
 IK class 05
 BUG Rating: B0-U3-G1
 Controllability: Phase dimming.



Product Code	Light source	Voltage	Finish	Item number	Price
PH3-2½B	1x15W A-19/IF medium	120V	Black	10000124039	1.536

TOLDBOD 6.1 BOLLARD

Bollard

Design: Louis Poulsen A/S

Concept: The light is directed 100% downwards and the shade has a matte white painted interior emitting a soft, diffused, comfortable light.

Finish: Black, powder coated.

Material: Shield: Tempered sand blasted glass. Luminaire head: Die cast aluminum. Post: Extruded aluminum. Base plate: Aluminum.

Mounting: Base plate dimension: 6" diameter. Base plate: Mounted to a concrete base with 3 anchor bolts on a bolt circle of 3.54" diameter. Installation: Refer to mounting instruction download for installation details.

Weight: Max: 5 lbs.

Compliance: cULus, Wet location.

Info notes: Electrical:
 Maximum Lamp Wattage: 60W
 Delivered lumens: 661 lm
 Efficacy: 3.0 lm/W

Certifications:
 cULus, Wet Location
 Protection class IP44
 IK class 05
 BUG Rating: B0-U1-G0
 Controllability: Phase dimming.

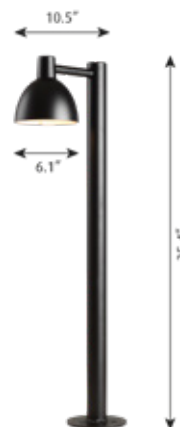

Product Code	Light source	Voltage	Finish	Pole/Post	Item number	Price
TOB-6.1	1x40W G16.5/IF candelabra	120V	Black Texture		5847901402	1.024
TOB-6.1	G16.5/IF candelabra	120V	Black Texture	POST W/BASE PLATE	5747916449	1.024

CONTENTS

alphabetic

Above	9	NJP Table	53	PH 5/5 Pendant	34
AJ 50 Wall	90	NJP Wall	69	PH 5 Mini	33
AJ Eklipta Outdoor	91	NJP Wall Box	70	PH 80	86
AJ Eklipta Surface	7	Nyhavn Wall	93	PH Artichoke	36
AJ Eklipta Wall	66	OE Quasi Light	22	PH Artichoke Glass	38
AJ Floor	79	PanHELLa Floor	83	PH Hat	73
AJ Garden Bollard	98	PanHELLa MINI	54	PH Louvre	39
AJ Mini Table	48	PanHELLa Portable	55	PH Septima	40
AJ Oxford Table Lamp	49	PanHELLa Table	56	PH Snowball	41
AJ Royal	10	PanHELLa Table 320	57	PH Wall	95
AJ Table	50	Patera	23	RipIs	8
AJ Wall	67	Patera Oval	24	RipIs	74
Bysted Garden Bollard	100	PH 2/1 Pendant	25	Skot Wall	96
Cirque	11	PH 2-1 Stem Fitting	26	Toldbod 6.1/8.7 Glass Pendant	42
Collage 450/600	12	PH 2/1 Table	58	Toldbod 6.1 Bollard	105
Dependant	13	PH 2-1 Wall	71	Toldbod 6.1 Wall	97
Doo-Wop	14	PH 3-2½ Bollard	104	Toldbod Pendant	43
Enigma 425	15	PH 3-2½ Wall	94	VL38 Floor	88
Enigma 545	16	PH 3/2 Glass Table	59	VL38 Table	64
Enigma 825	17	PH 3-2 Wall	72	VL38 Wall	77
Flindt Garden Bollard	102	PH 3/3 Pendant	27	VL45 Radiohus Pendant	46
Flindt Wall	92	PH 3½-2½ Floor	84	VL Ring Crown 1	44
Keglen	18	PH 3½-2½ Glass Table	60	VL Ring Crown 3-5-7	45
Keglen Floor	80	PH 3½-2½ Table	61	VL Ring Crown Wall	75
Keglen Table	51	PH 3½-3 Glass Pendant	28	VL Studio Table/Floor	87
Keglen Wall	68	PH 3½-3 Pendant	29	VL Studio Wall	76
LC Shutters	19	PH 4/3 Table	62	Wohlert	47
LP Centrum	20	PH 4½-3½ Glass Floor	85	Yuh Floor	89
Moonsetter	81	PH 4½-3½ Glass Table	63	Yuh Table	65
Moser	21	PH 4½-4 Glass Pendant	30	Yuh Wall	78
NJP Floor	82	PH 5	31		
NJP Mini	52	PH 5-4½ & PH 6½-6	35		

louispoulsen.com